

FORD

'93

PROBE

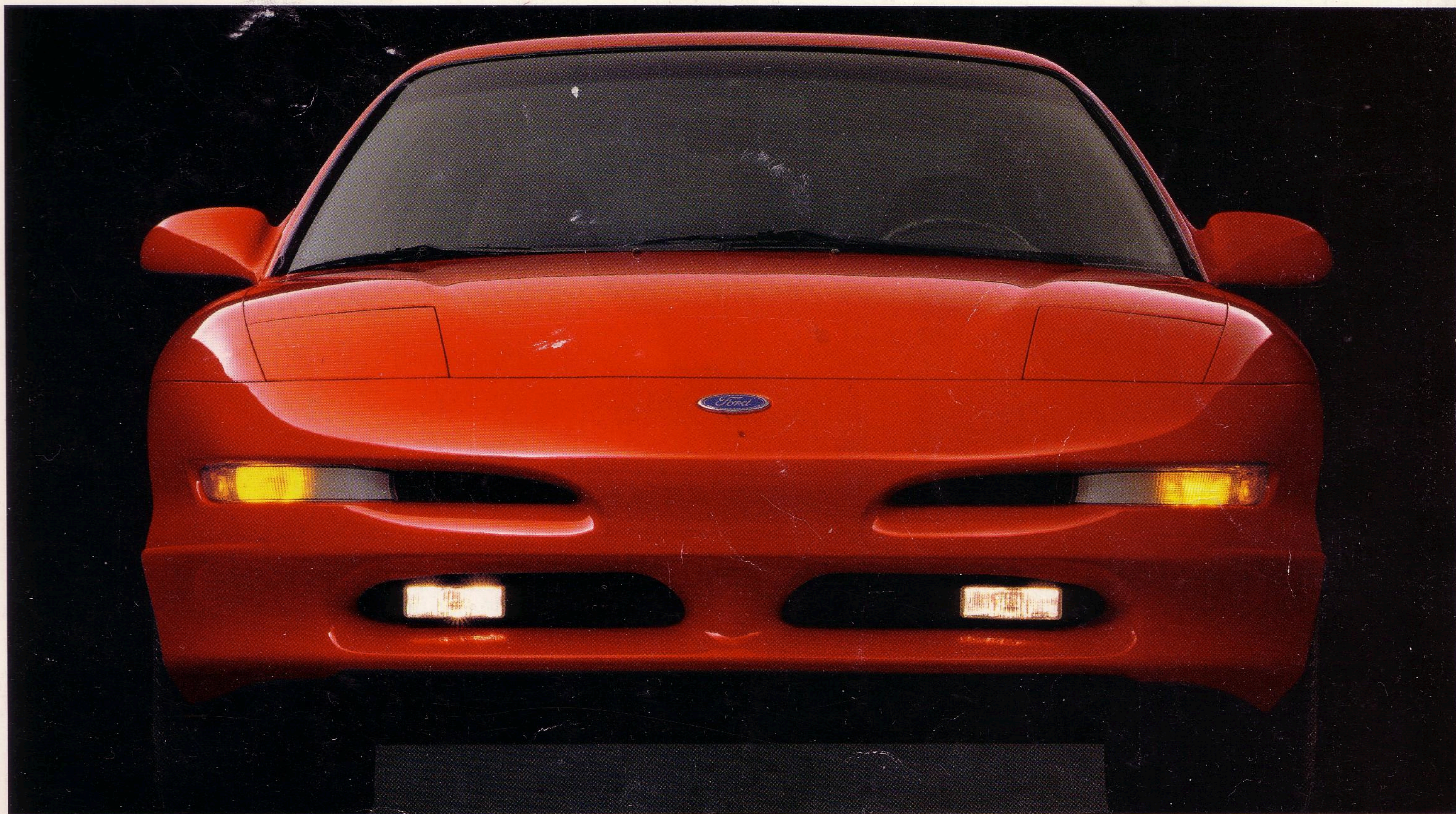

PROBE 1993

Create a "pure" sports coupe in the honest sense of the word. A sports coupe in which all that matters is the enjoyment that comes with being in direct link with the road.

A pure driving experience. Nothing less.

This was the task we gave a team of designers and engineers. And this is what they created.

The all-new 1993 Probe from Ford.

A driver's car whose every attribute of style and performance captures the true qualities of the genuine sports coupe.

These qualities you can see in styling that is purposeful: The fluid contours of the aerodynamic body and the smoothly integrated instrument and door panels, for example.

And you can feel them in the performance. The responsive acceleration of a multi-valve multi-port electronic fuel-injected engine. The tight handling and cornering capability of a

finely balanced 4-wheel independent

suspension. The body-con-

toured seating and driver-

command instruments and con-

trols of a superbly ergonomic

cockpit as well.

The '93 Ford Probe is available in two exciting models.

We've made each unique in both style and performance.

And in their lists of standard features you'll find a driver air bag Supplemental Restraint System (SRS).

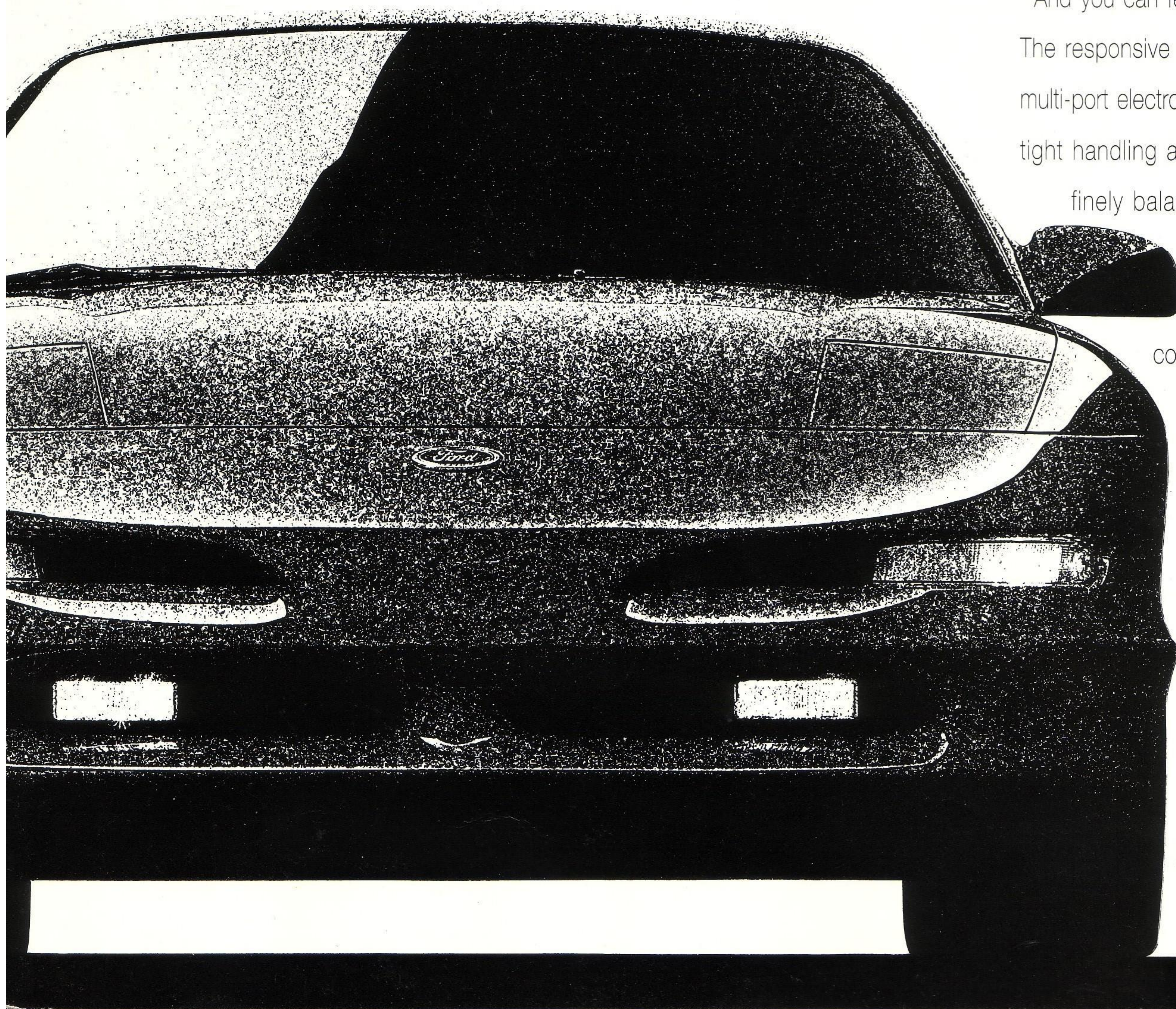

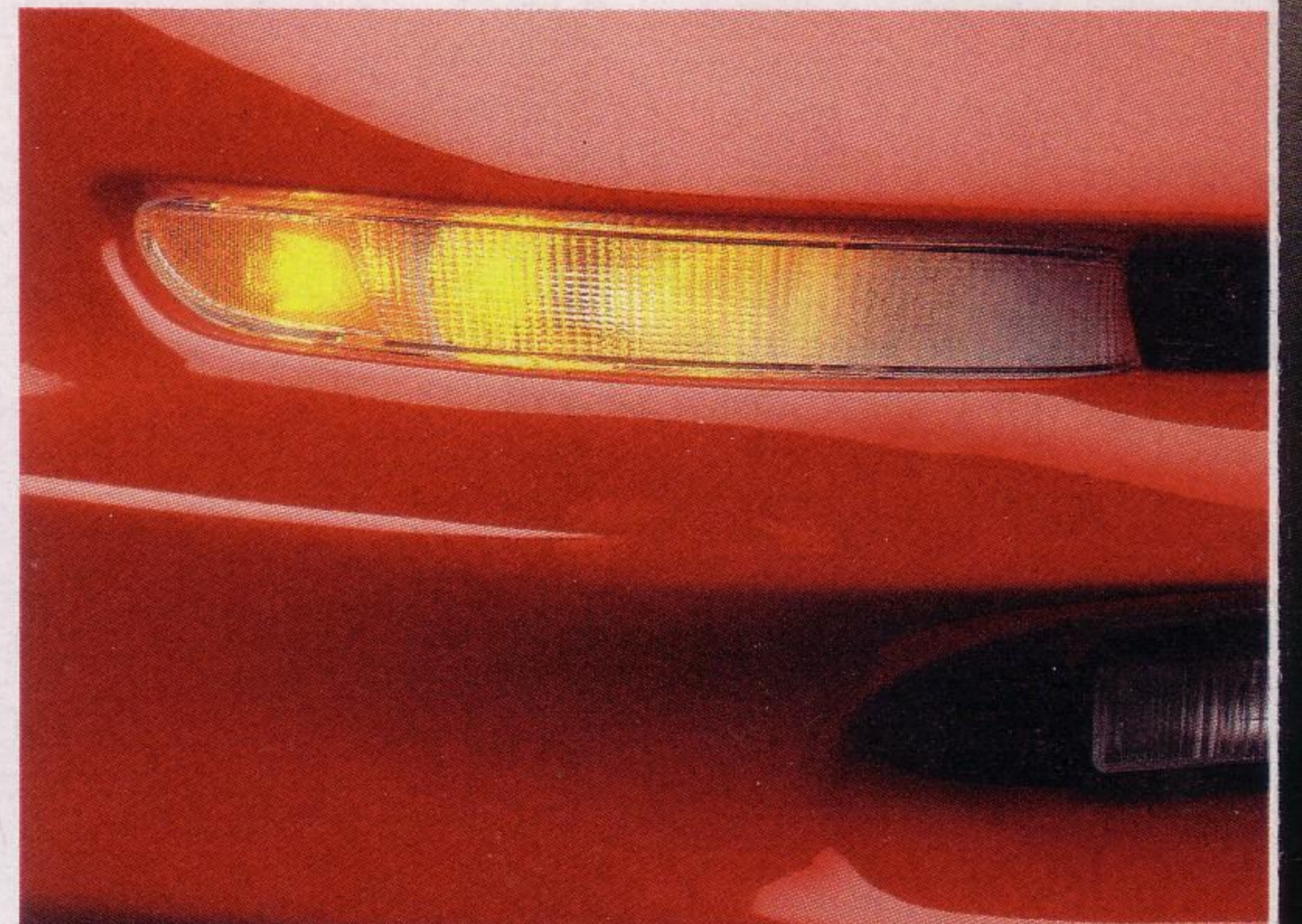
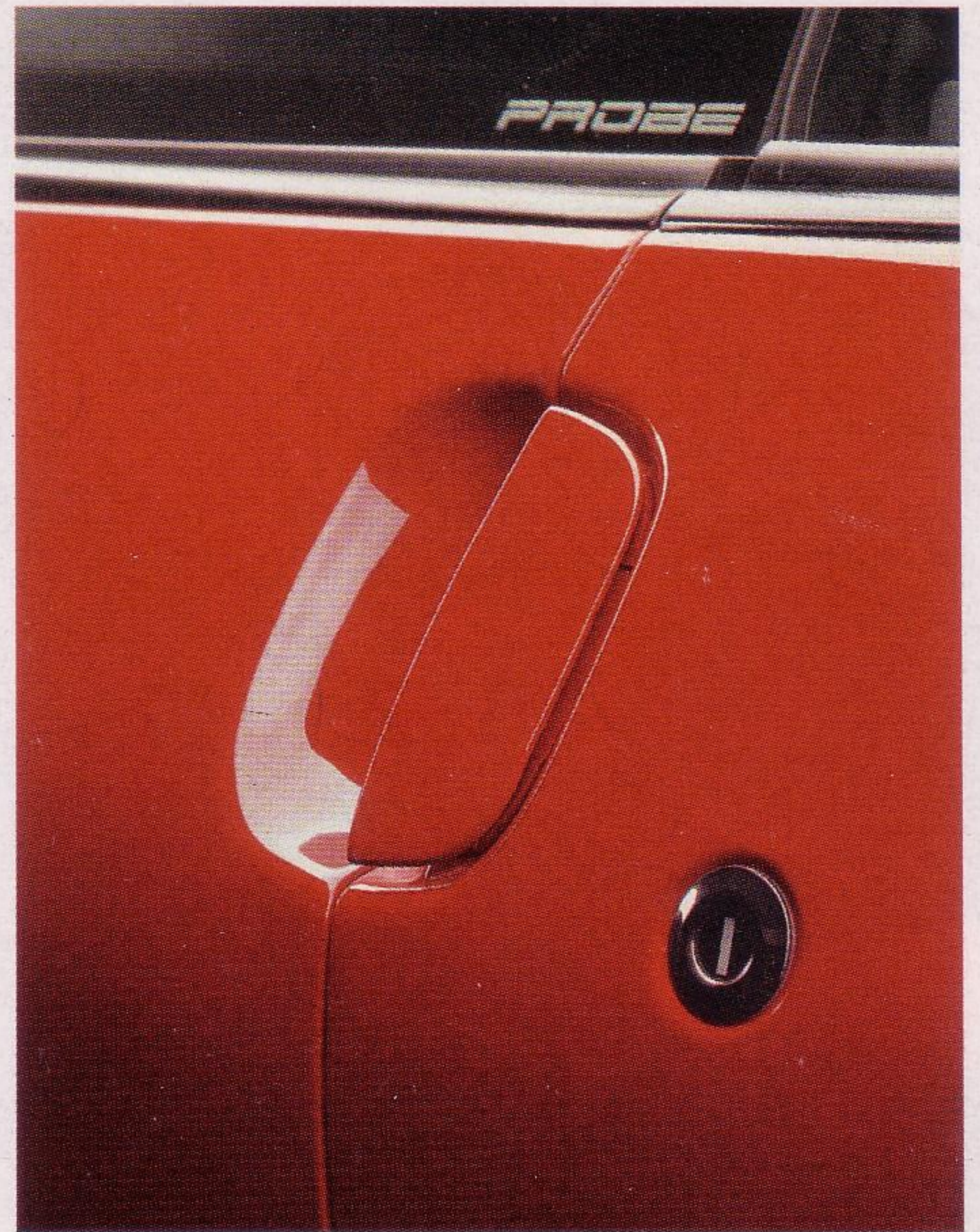

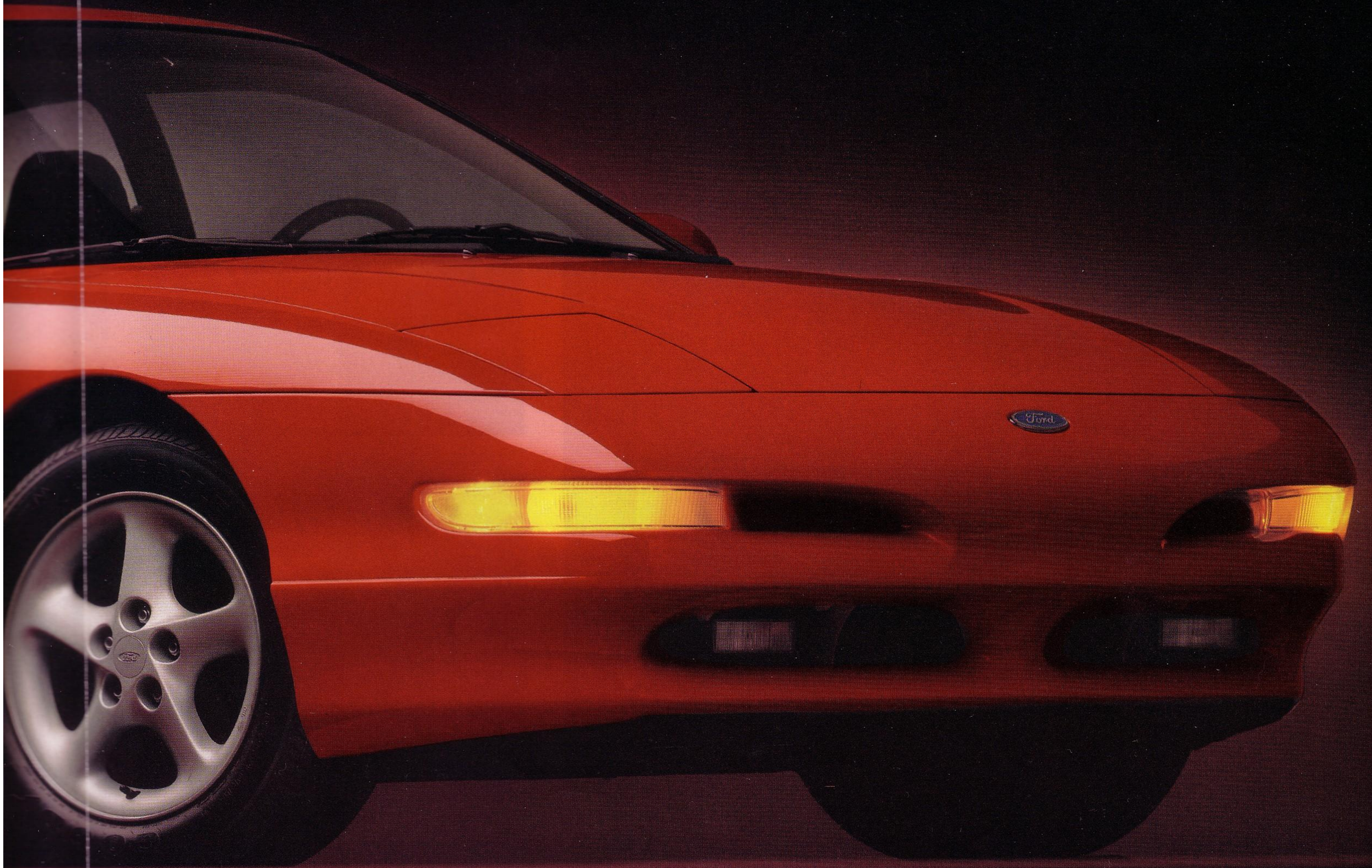

Unique front and rear fascias, front fog lamps, lower bodyside cladding, and wide-stance 16-inch performance tires on aluminum wheels. The look of Probe GT says driving enjoyment. And exciting power and handling make it happen. The GT featured here is in Rio Red (tinted non-metallic) Clearcoat. Some equipment shown is optional.

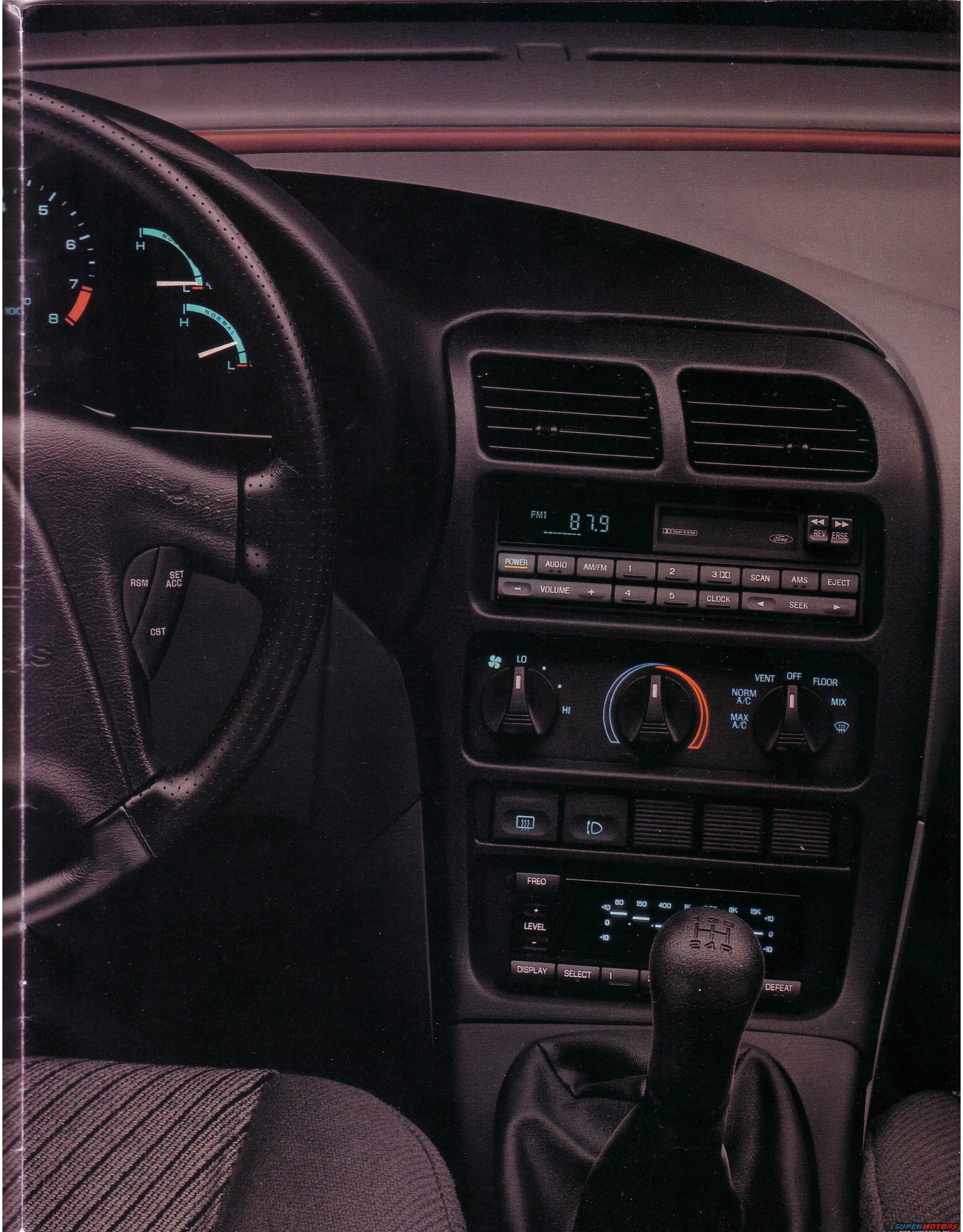

RSM SET ACC
CST

FM1 87.9

POWER AUDIO AM/FM 1 2 3 SCAN AMS EJECT
- VOLUME + 4 5 CLOCK SEEK

LO HI VENT OFF FLOOR MIX
NORM A/C MAX A/C

FREQ
+ LEVEL -
DISPLAY SELECT 1 DEFEAT

DRIVER CONTROL

Maximum driver control. It's what every interior designer strives for in a performance-oriented car.

Many ergonomic factors are carefully examined in the effort to achieve it, such as the size and placement of controls, their frequency of use, and the effort required to operate them; the location and legibility of instruments; hand/eye movement; driving posture; and field of vision.

On Probe's driver-oriented instrument panel, you'll find important operating information

The principle of correct ergonomic design: A car that is more comfortable and easier to drive is more enjoyable to drive.

located directly in your line of sight beneath a low windshield cowl line. The cluster features the clarity of analog gauges, including a tachometer, fuel gauge, engine coolant temperature gauge, oil pressure gauge, and voltmeter. A trip odometer, too.

The controls, some on two steering column levers, are easy to reach and operate so that you can concentrate attention primarily on the road.

Ergonomic convenience is also evident in the pronounced driver-biased angle of the centre panel and console. The shift lever is carefully located in relation to your seating position.

In the new Probe for 1993 you have a superb ergonomic design. And what's more, for your added safety, Probe is equipped with a driver air bag Supplemental Restraint System (SRS).

Probe GT instrument panel (at right) and interior (following pages) in Opal Grey. Some equipment shown is optional.

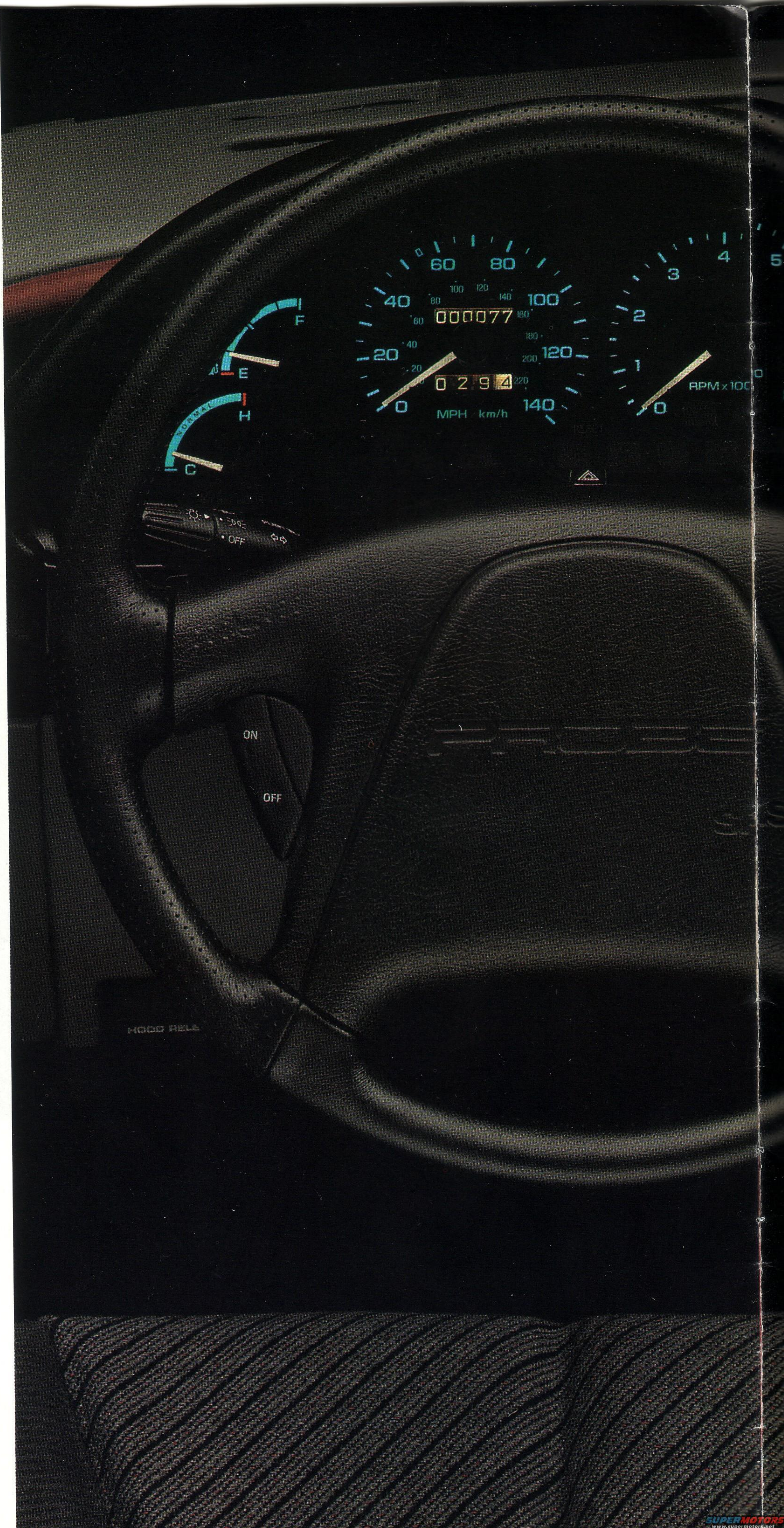



PROBE
SRS

FMI 88.7

POWER AUDIO AM/FM
VOLUME

LO HI

FREQ
LEVEL
DISPLAY SELECT

5-2-1
2-3-4



PROBE



The '93 Ford Probe is designed and engineered for performance — from its aerodynamically sculpted body shell to its ergonomically crafted cockpit; from its 4-wheel independent suspension to its 16-valve, DOHC 2.0-litre I-4 engine.

Take in hand the smooth-shifting 5-speed manual transaxle which comes standard. Or choose the optional 4-speed automatic. Capable of

sensing the speed at which you depress the pedal, Probe's electronically governed automatic transaxle will downshift one or two gears (within reasonable limits of speed) to generate the degree of acceleration you desire.

Add a list of standard features including body-contoured bucket seats, analog gauges, an AM/FM stereo sound system, a driver air bag

supplemental restraint system, and 50/50 split rear seats, to name just a few. You now have a sports coupe equipped for outstanding value.

Probe has some other great options too: a power sliding roof, leather seating surfaces (see your Dealer about delayed availability), 4-wheel disc anti-lock brakes, a compact disc player, and a unique 7-band stereo graphic equalizer.

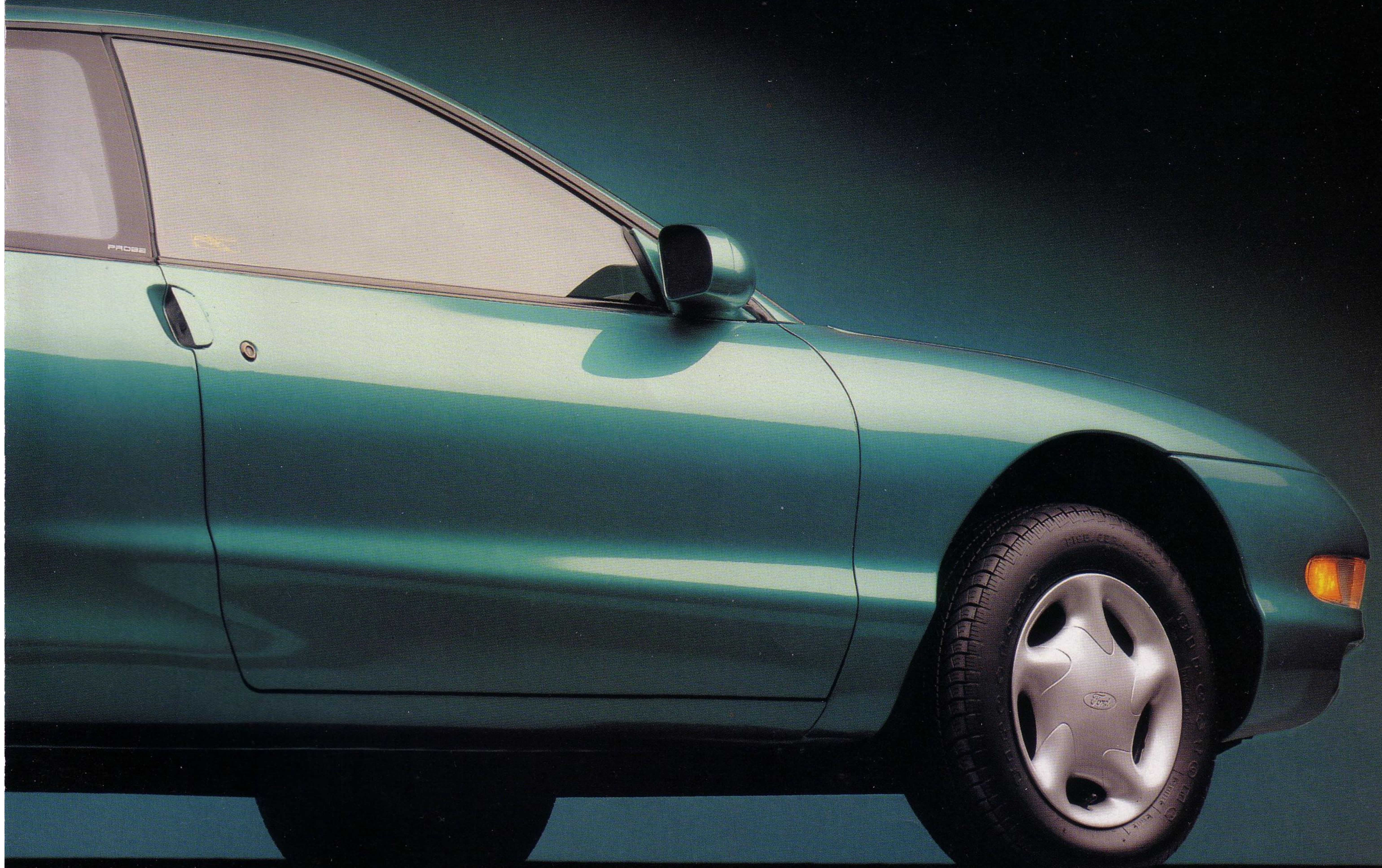

Above: Probe in Bright Calypso Green Clearcoat Metallic.

At left: Probe in Silver Clearcoat Metallic. Some equipment shown is optional.

SAFETY AND CONVENIENCE

When we engineered the new Ford Probe sports coupe, we had two important goals in mind: Driving enjoyment. And safety.

Responsive power, handling and braking are certainly essential for driving enjoyment. But they're just as essential for "operating safety" — the term that applies to how well your car is engineered to help you avoid an accident.

Then there are "occupant protection" features designed to protect you if an accident occurs.

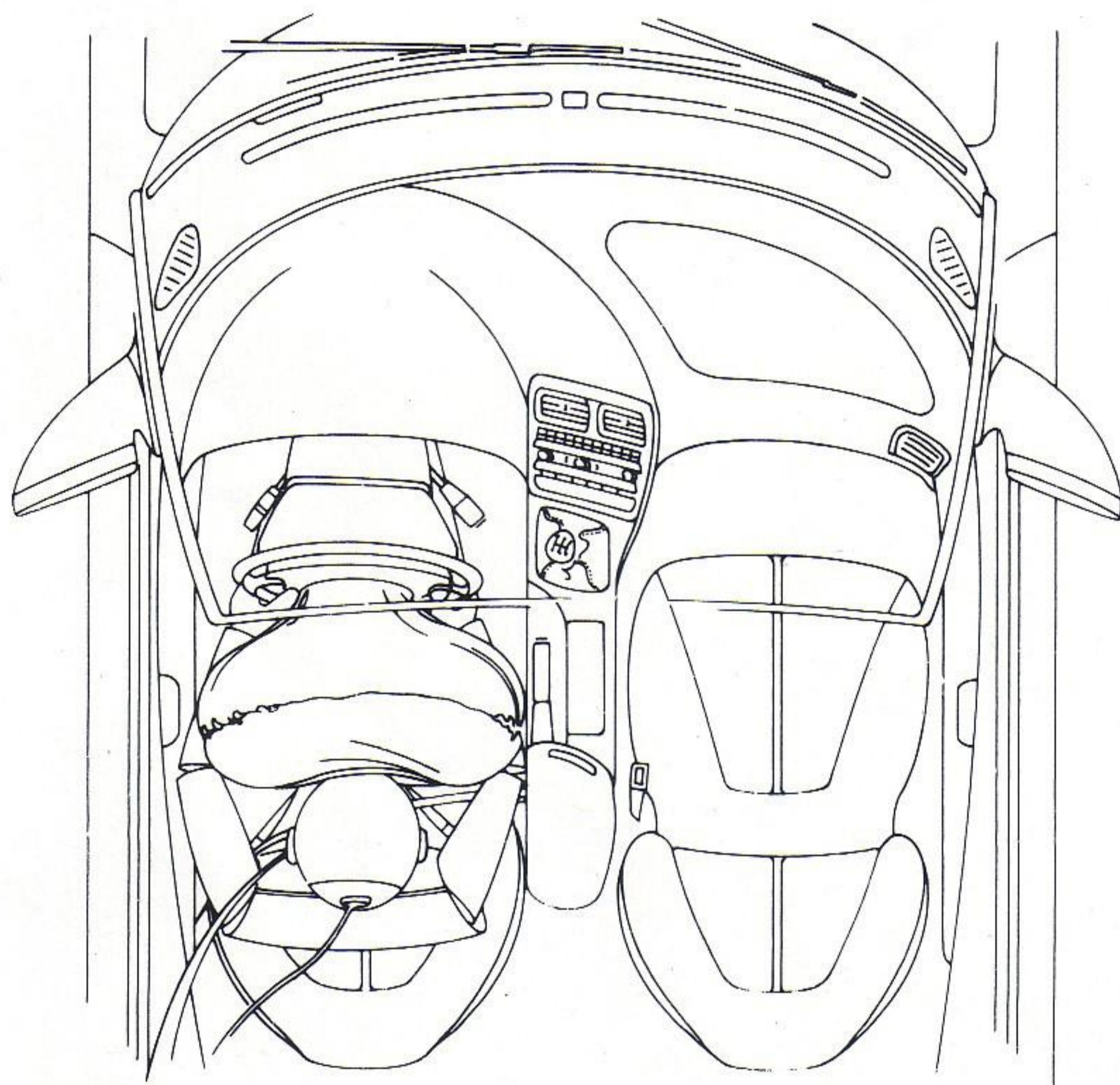

Among the many occupant protection features in the 1993 Ford Probe is a standard driver air bag Supplemental Restraint System (SRS).

The SRS is designed to activate in a frontal impact roughly equivalent to striking a parked car of comparable size at 45 km/h (28 mph).

From initial impact to full deployment, the air bag inflates in less than 1/10 of a second. And it begins to deflate in just a fraction of a second.

Important as the air bag is, always remember that it's intended to supplement, not replace, your lap and shoulder safety belt system, which provides protection in all types of impacts.

Dual electric remote mirrors are included in all Preferred Equipment Packages. "Heated" mirrors are included with the optional rear wiper/washer.



To suit individual needs, there's an optional driver's seat manual height adjust feature to go along with the standard fore/aft seat track adjustment.

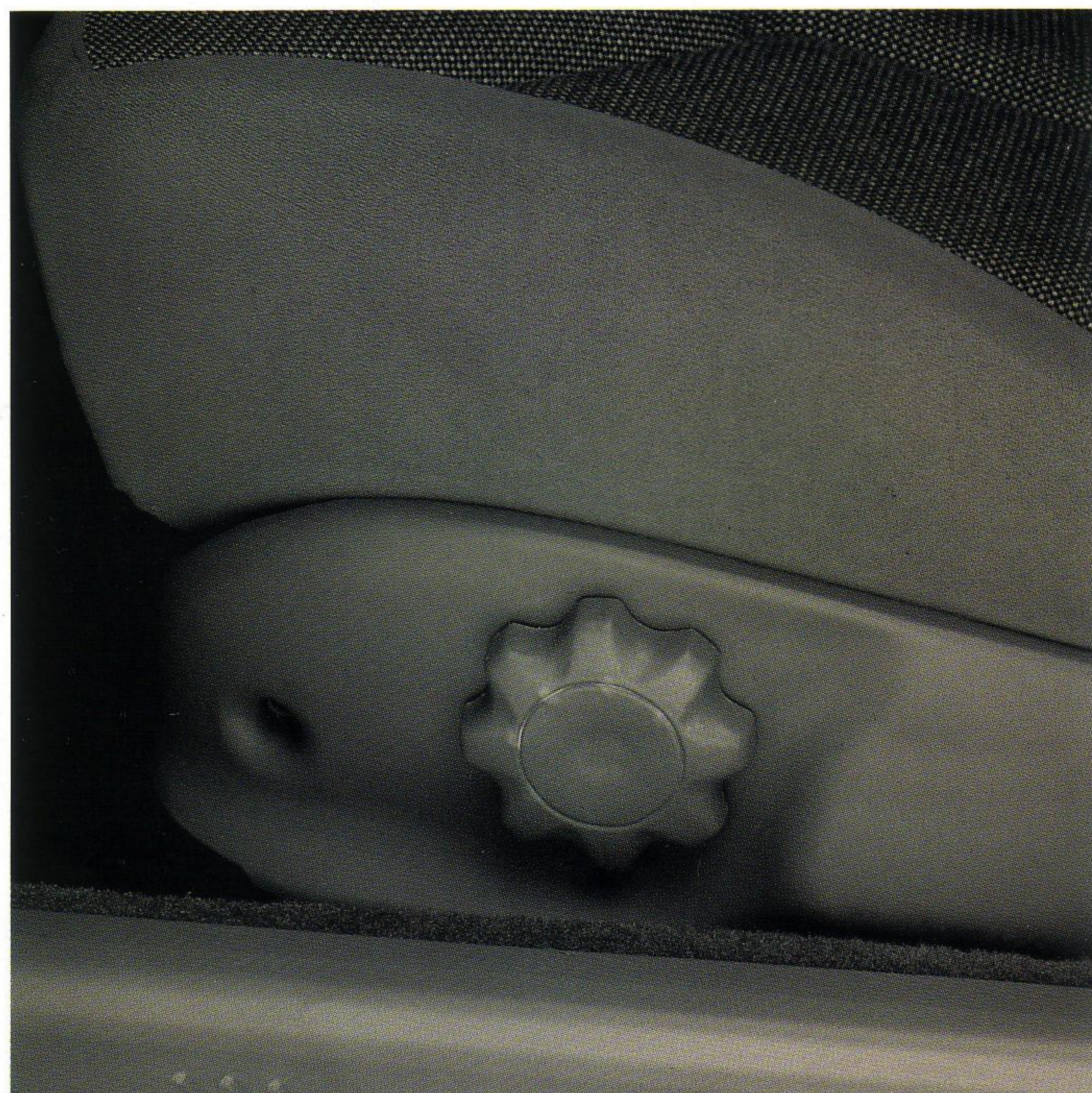

A convenient "memory" feature returns your forward-folded seat-back to the exact position you previously set.





On the centre panel console are the heating/cooling and stereo system controls. As you can see on pages 8-9, this important feature of Probe's ergonomic design is angled toward the driver.

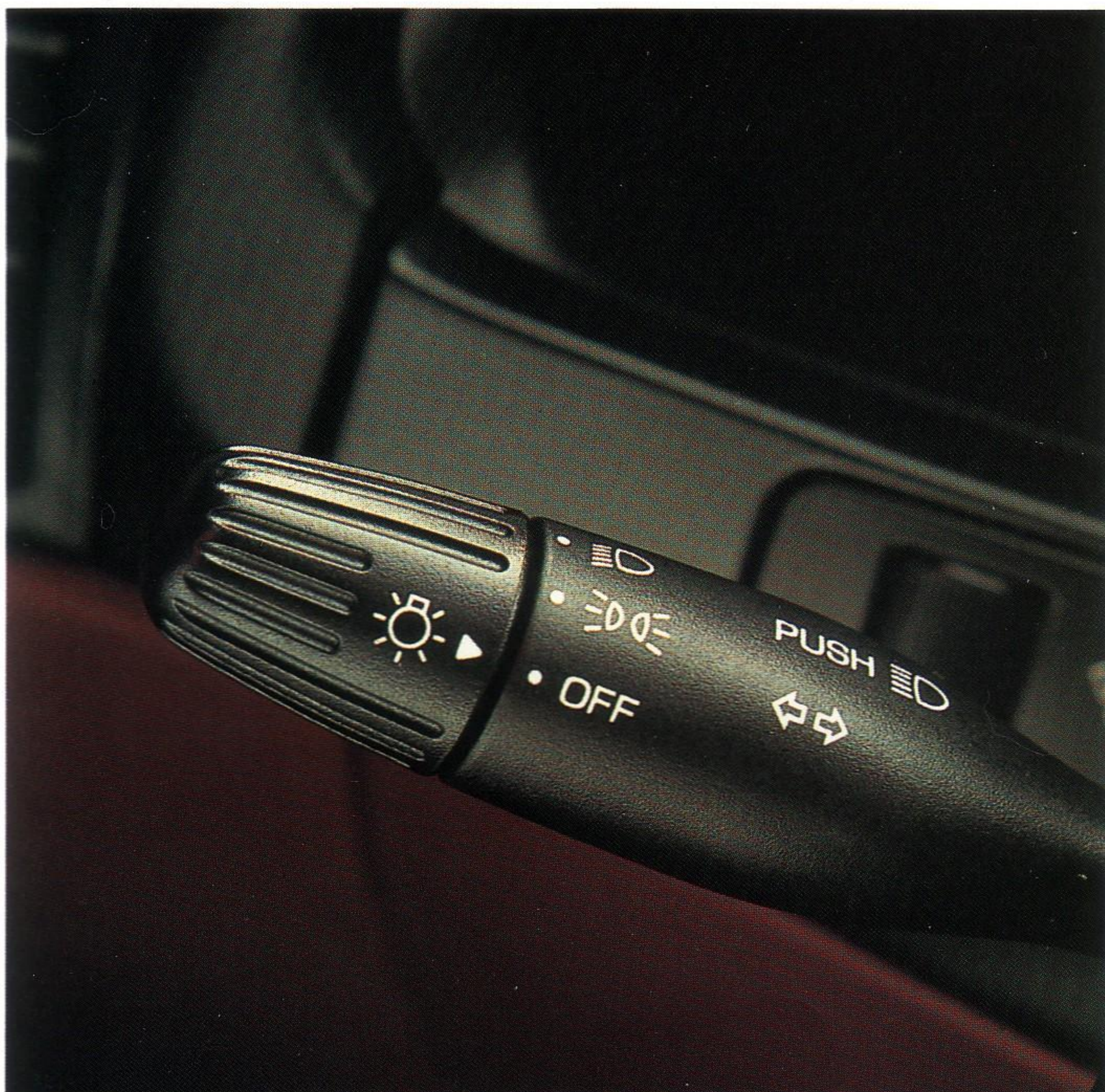

Several important operating controls (headlamps, turn signals, windshield wipers/washer) are located within easy reach on two steering column-mounted levers.

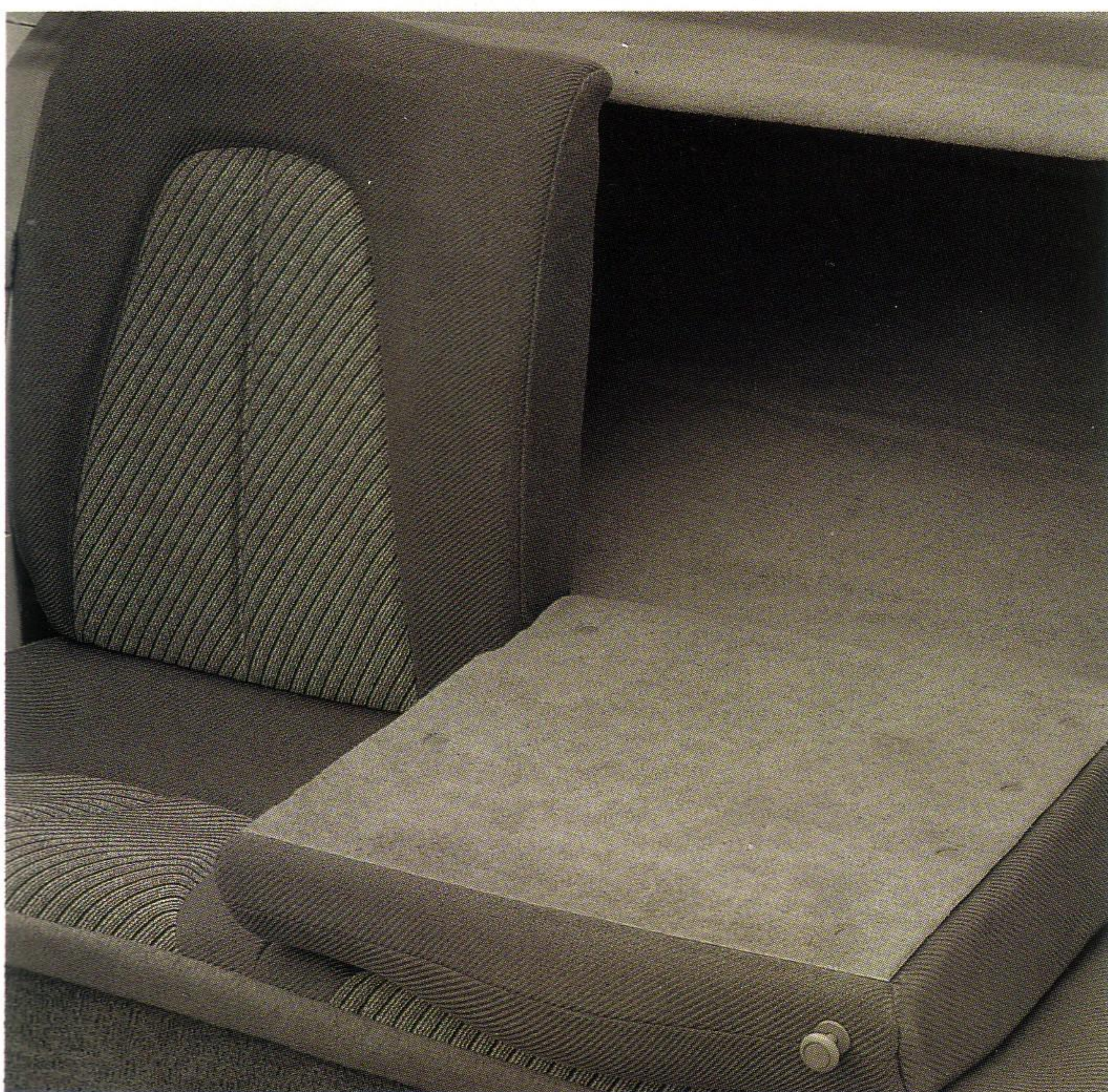

50/50 split rear seat backs can be lowered individually, allowing for added luggage or cargo either with or without a third passenger.

Air vents at the end of the instrument panel help keep the side windows clear of fog or mist.

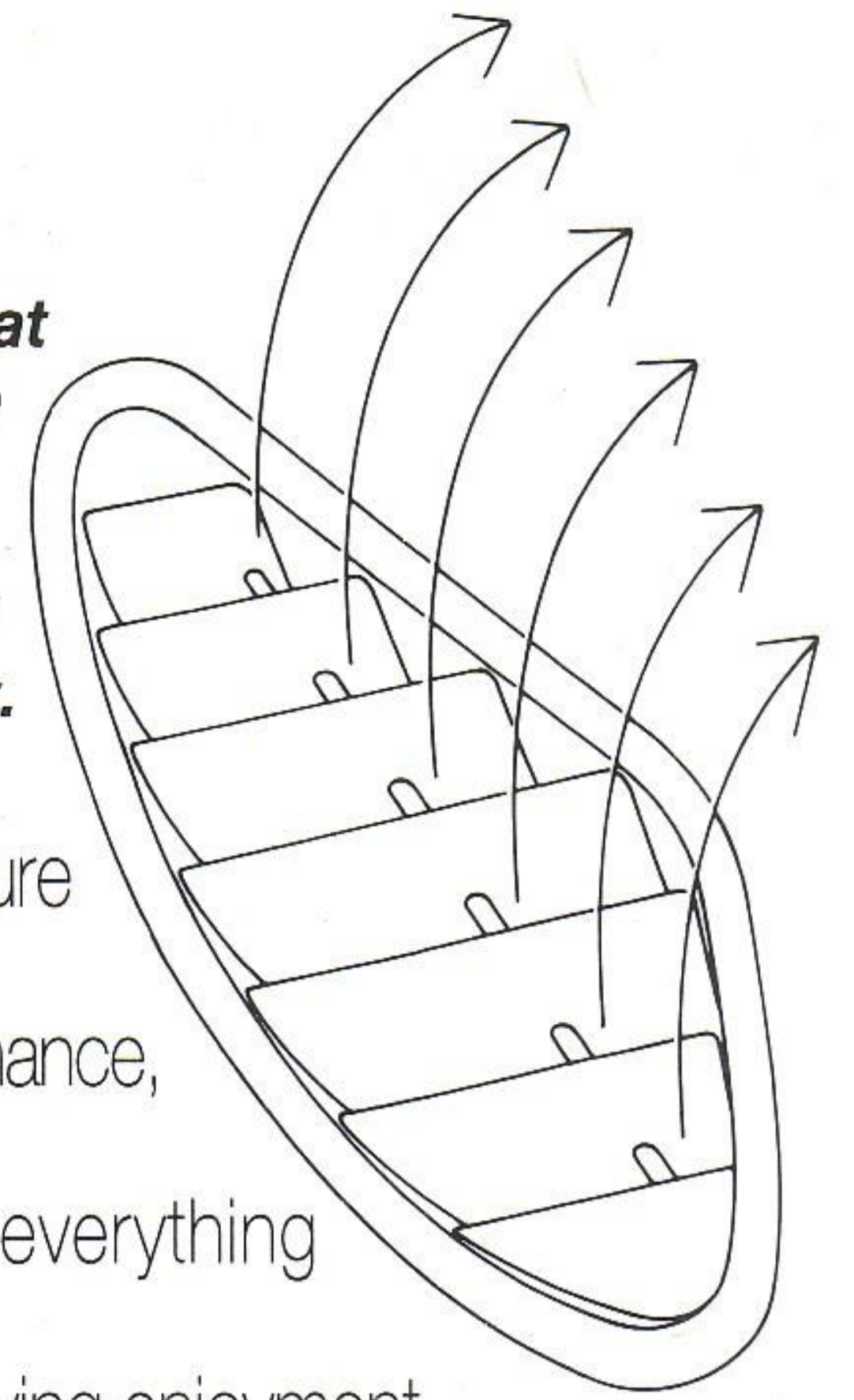

To get the best picture of Probe's total performance, you have to look at everything that enhances your driving enjoyment.

The clarity of full analog gauges. Heating/cooling and stereo system controls in a driver-biased centre panel console. Controls on two column-

Performance is experienced in a lot of ways, even in the smallest convenience that contributes to your driving enjoyment.

mounted levers (headlamps and turn signals on the left; windshield wipers/washer on the right). Features such as

these, carefully designed and positioned, you'll find in this superbly ergonomic sports coupe.

In Probe you also have in its list of conveniences: a "memory" feature that returns your forward-folded seat-back to the exact position you set, push-button stereo controls, side window demisters, and the versatile 50/50 split-folding rear seat-backs.

And among the options on page 21: Electric "heated" remote-control mirrors (with the rear wiper/washer). Speed controls on the steering wheel. Plus two new features in the Power Group — the "express down" design that lets the driver lower either side window at the touch of a button; plus the ability to unlock one or both doors from the outside with a turn of the key.

PROBE HANDLING

Handling control plays such an important role in the driver/sports coupe relationship, engineers designed the components of Probe's suspension, steering, and braking systems to perform as a single, integrated handling system.

Probe has a 4-wheel independent suspension with MacPherson struts/coil springs all around. Its stabilizer bars, strut valving, spring rates and bushings are specifically tuned for an excellent

In a car engineered for the true driving enthusiast, all the individual chassis components work together as a single handling system.

balance of ride quality and tight, solid handling. The front suspension tuning, steering geometry and the half-shafts of equal length work together to virtually eliminate the condition called "torque steer" — the tendency of the car to turn in a particular direction when hard acceleration is applied.

The quadra-link rear system is designed to offset the wheels' natural inclination to "toe-out" under the forces of acceleration, cornering and braking (which can reduce stability and control) by eliminating toe change. This enables the wheels to maintain their effective alignment for excellent sensitivity to directional changes.

In Probe you have the added traction of front-wheel drive. The rack-and-pinion power steering system is precise, with a firm on-centre feel. The power brakes are responsive and resistant to fade. And for world-class stopping capability, there's the optional 4-wheel disc anti-lock brake system.

Virtually eliminated is the tendency to turn in a particular direction when hard acceleration is applied — a condition called "torque steer."

Probe responds precisely to driver inputs in highway-speed manoeuvring as well as in lower-speed cornering. The quadra-link rear suspension system, for example, is designed to offset the car's tendency to "toe-out" under the forces of acceleration, cornering and braking by eliminating toe change.

Excellent roadholding is the result of many integrated systems components: Tuned strut valving, spring rates, bushings, and stabilizer bars. Quadra-link rear suspension design that helps keep the wheels in proper alignment for stability and control. Plus low aspect-ratio radial tires.

With its sport-tuned suspension components and low-profile 16-inch performance radials, the GT takes Probe's excellent handling capability to even greater heights of high-performance driving enjoyment.

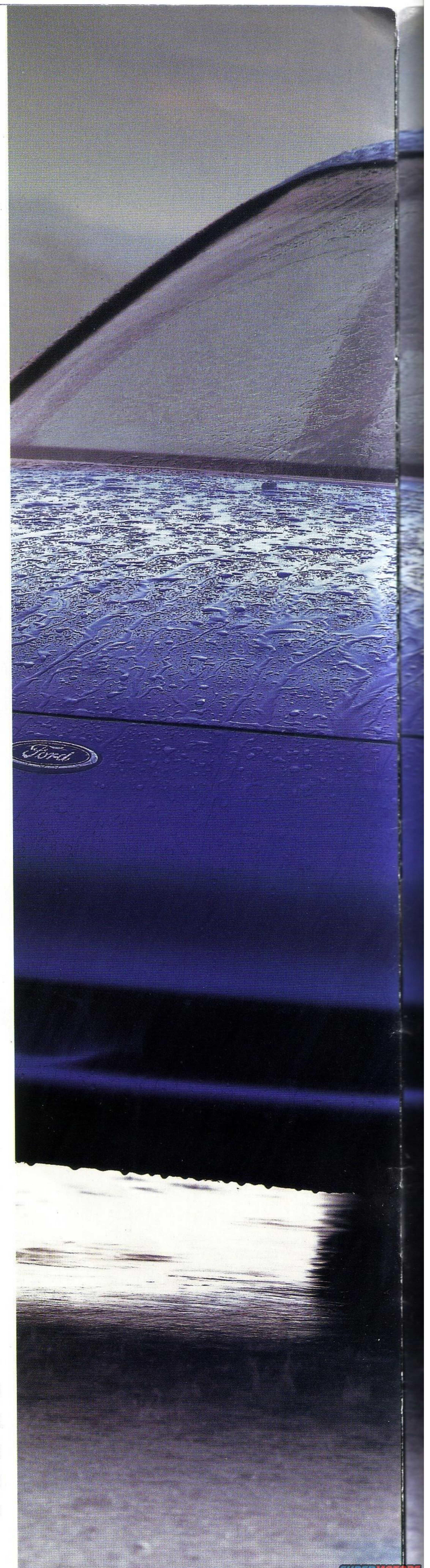
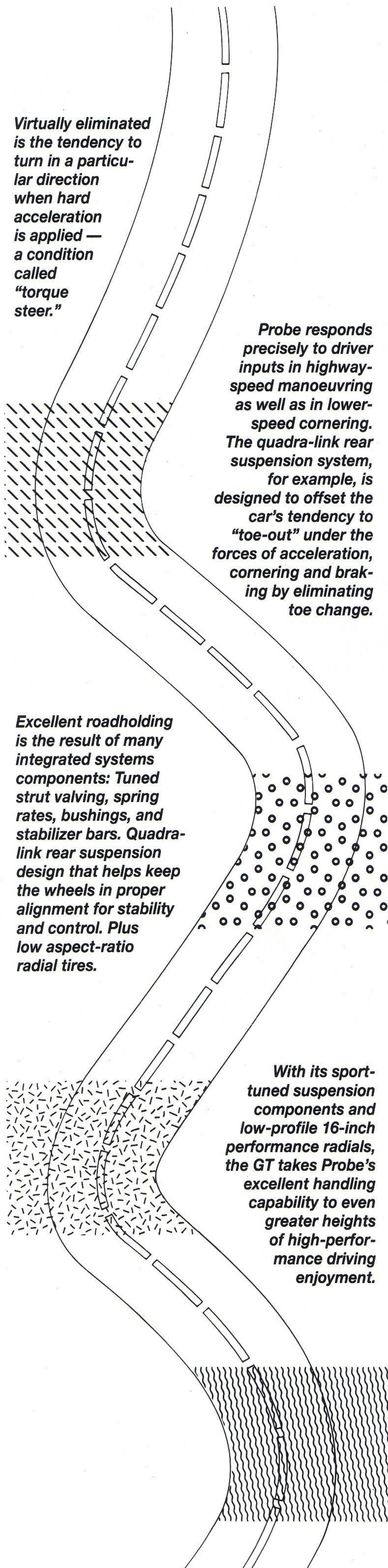

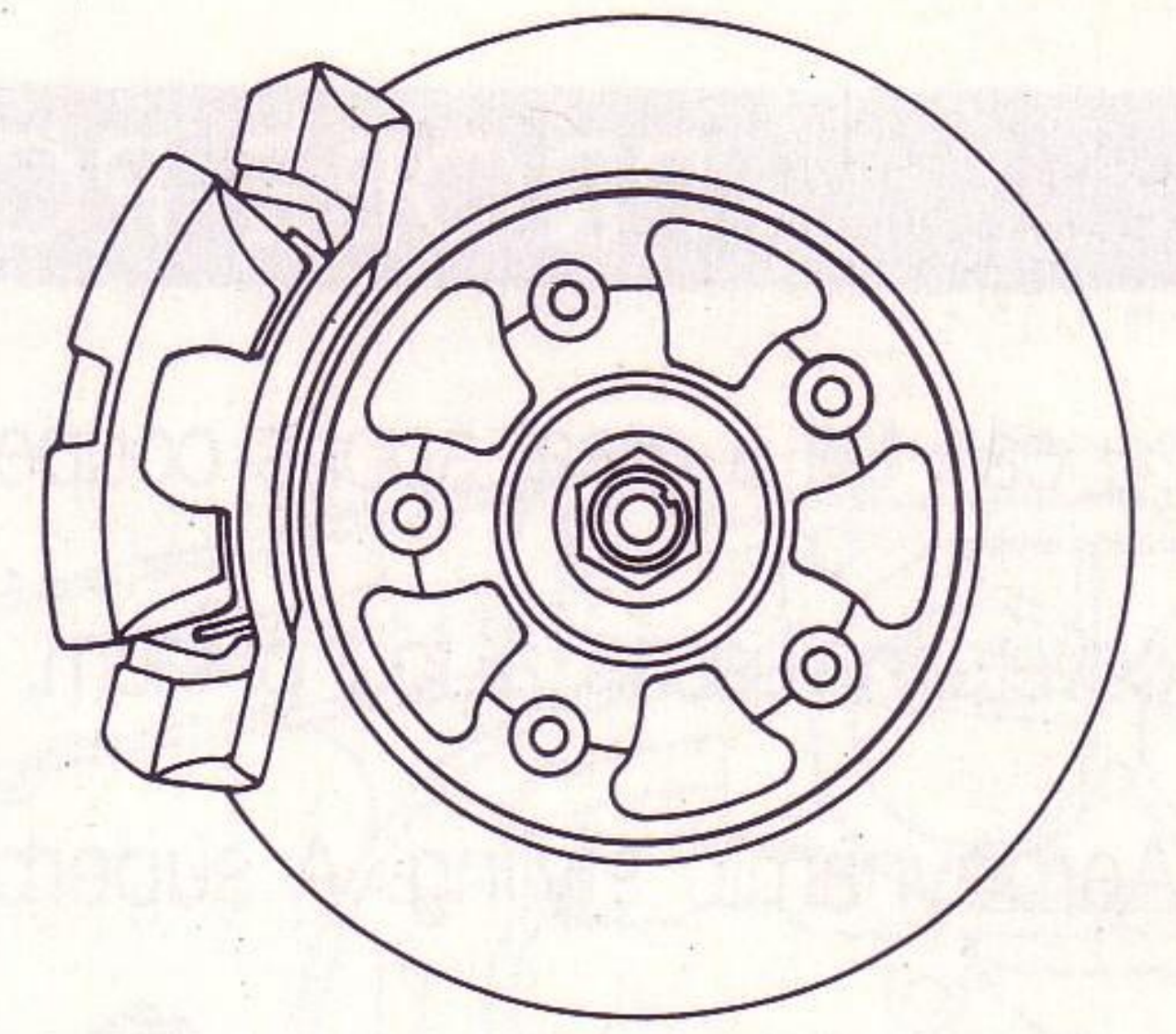

The standard Probe has power-assisted front disc/rear drum brakes. The GT comes with 4-wheel discs. A computer-controlled anti-lock system is available in both models.

The computer-modulated anti-lock brake system prevents the wheels from locking up in a hard braking situation by applying and releasing the brakes at a rate of speed far exceeding that of human capability — up to 10 times per second. It's much like a professional driver who skillfully "pumps" the brakes, only a great deal faster.

The advanced technology of anti-lock braking helps provide greater steering control and smooth, straight stops under most conditions, even on wet and slippery roads.

Rack-and-pinion power steering is precise and responsive. On-centre feel is firm, enhancing straight-line stability.

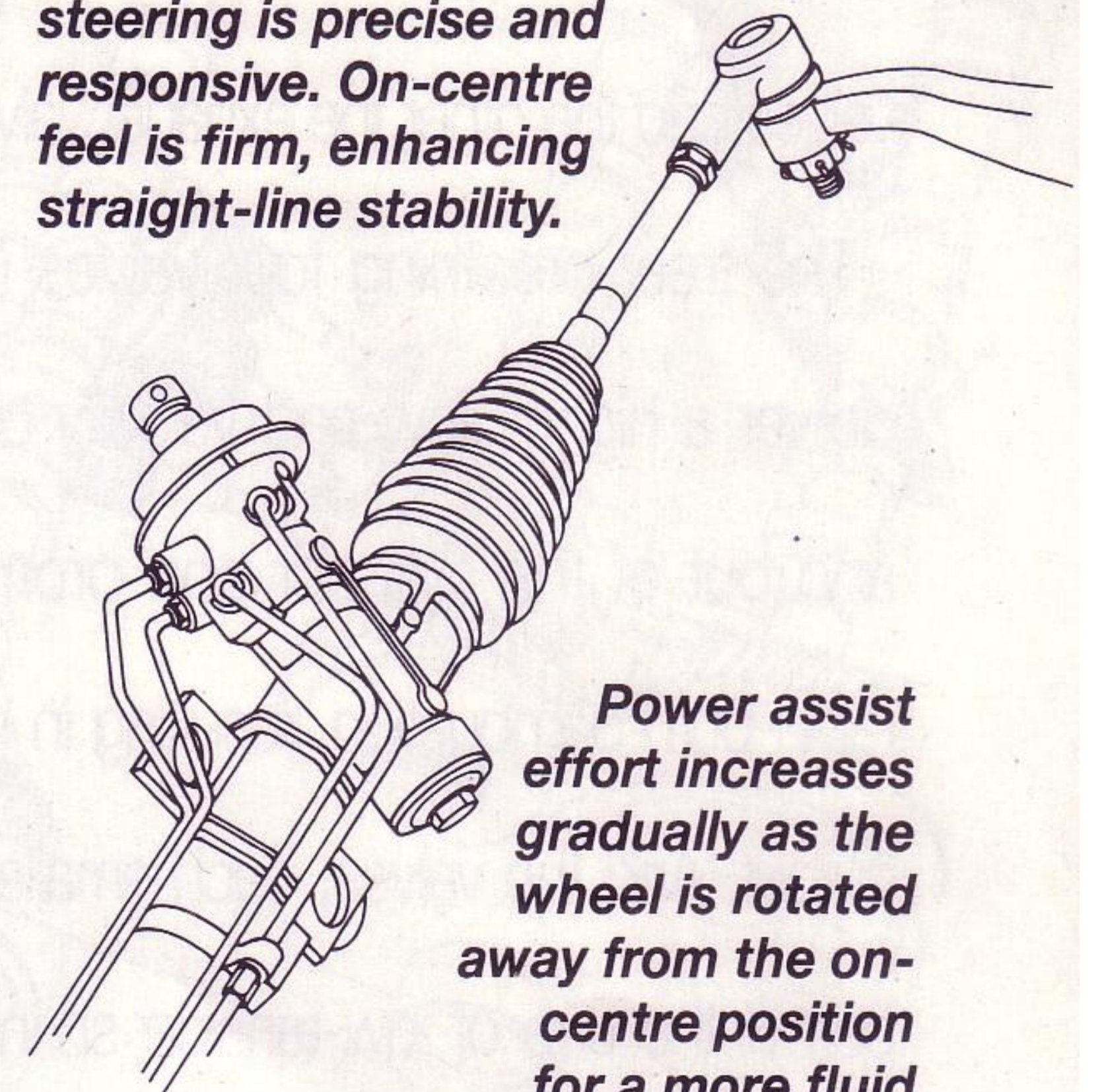

Power assist effort increases gradually as the wheel is rotated away from the on-centre position for a more fluid feel of the wheel.

PROBE POWER

You can tell a great sports coupe by the way it covers the bases, all four of them.

Aerodynamic styling. A superb ergonomic design. Agile handling. And responsive power.

The powertrain engineer's job in the design of a dynamic sports coupe is clear: Inject as much of a precisely metered mixture of fuel/air as possible, and as quickly as possible, into each cylinder. Burn it evenly and rapidly. Then

Probe's multi-port fuel-injected I-4 and V-6 engines feature the free-breathing 4-valve-per-cylinder design with dual overhead cams. release the exhaust with comparable efficiency. The whole idea here is to extract optimum power from every drop

of fuel, and to deliver responsive power and torque over the complete performance range — from accelerating off the line to passing at highway speed.

The design that puts this idea into motion is the one long embraced by designers of racing engines: four valves per cylinder (two for intake and two for exhaust) and belt-driven twin overhead camshafts (one activating the intake valves and the other the exhaust valves).

The freer-breathing four valves (versus two) deliver a higher flow and velocity of fuel/air into and out of the cylinder and promote greater rapid-burn combustion, resulting in higher power output. And the valves, each smaller and lighter, permit the use of low-tension springs, enabling the engine to reach higher rpm more quickly.

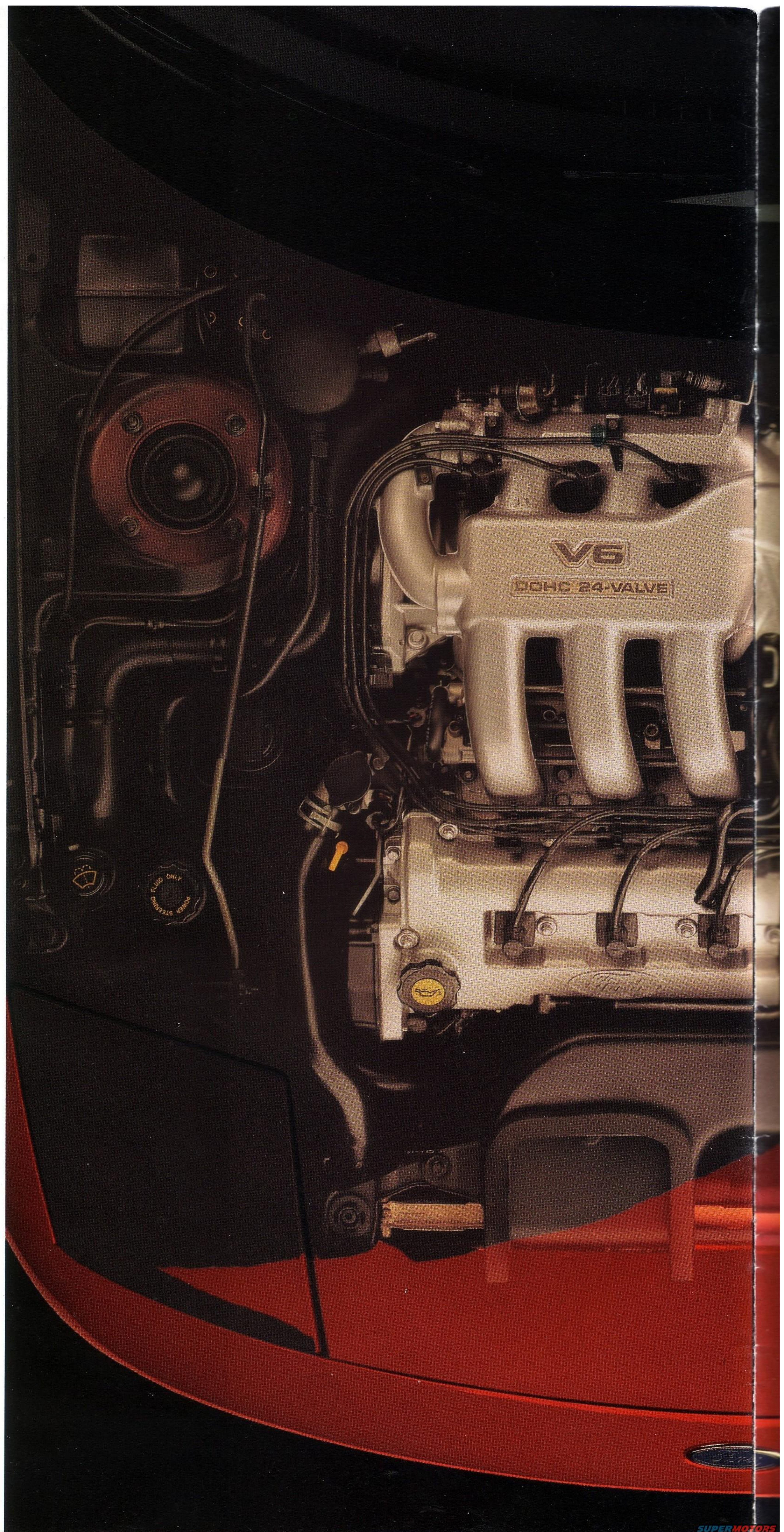

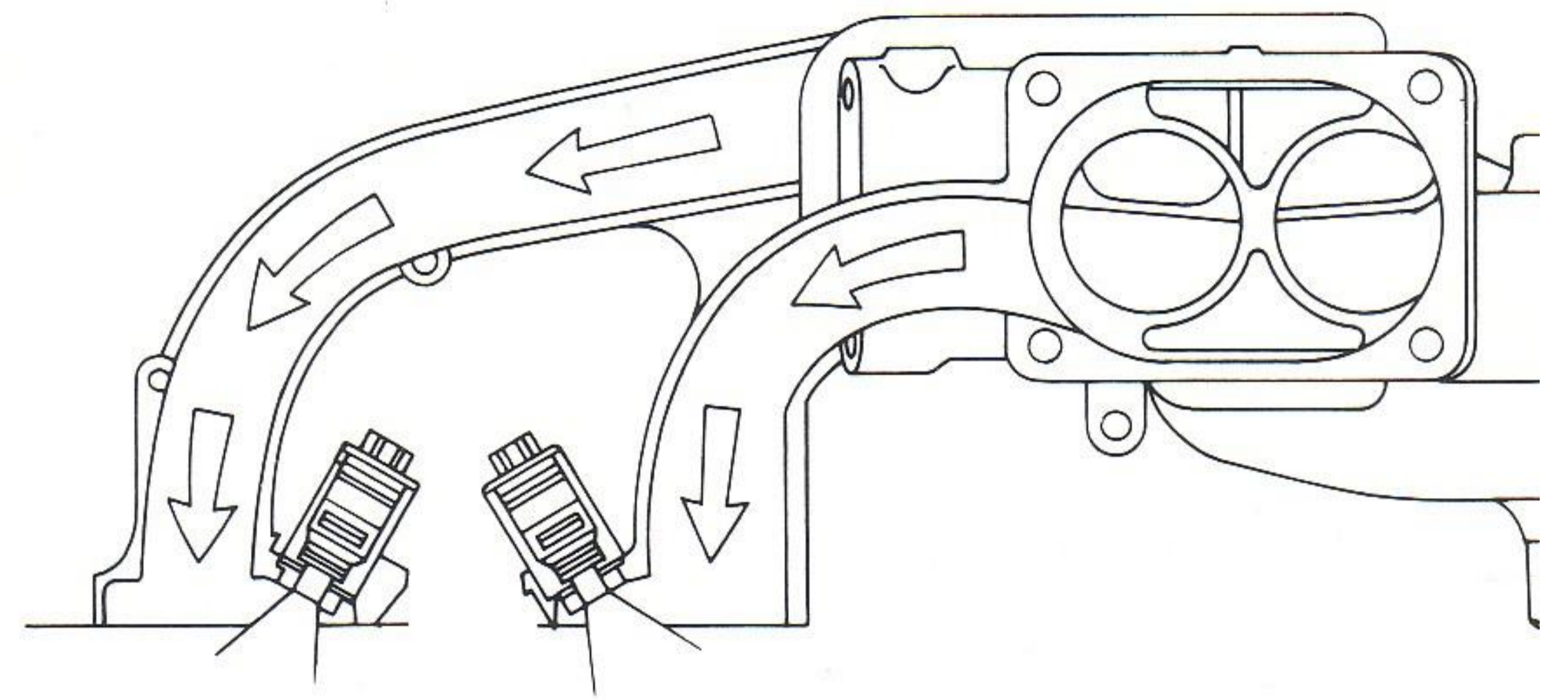
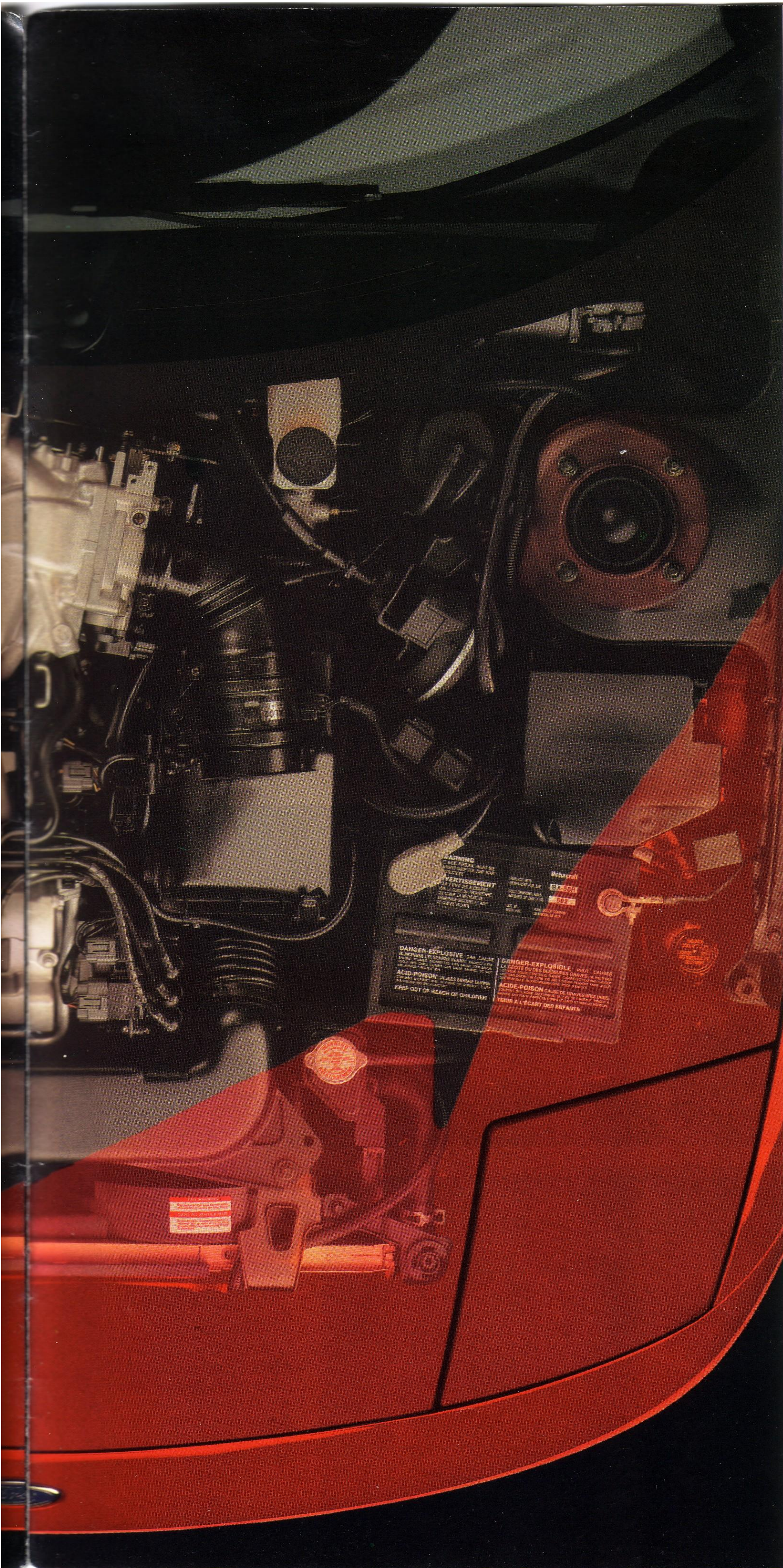

Computer-controlled, multi-port electronic fuel injection provides precise fuel metering for efficiency and smooth running.

Equipped with multi-valve technology, plus the precision of a computer-controlled multi-port electronic fuel injection system, Probe engines deliver excellent power-efficiency.

Enjoy sport performance with the responsive 2.0-litre I-4 in Probe or the higher-performance 2.5-litre V-6 under the hood of the Probe GT.

Especially impressive is the GT's high ratio of power (164 SAE net hp) to displacement (153 cu. in.). That's more than one horsepower per cubic inch. Note also its turbine-like sound, a quality prized by driving enthusiasts who really appreciate quality-engineered performance.

Four valves per cylinder (two for intake, two for exhaust), actuated by belt-driven dual overhead camshafts, promote high-flow/velocity breathing and rapid-burn combustion.

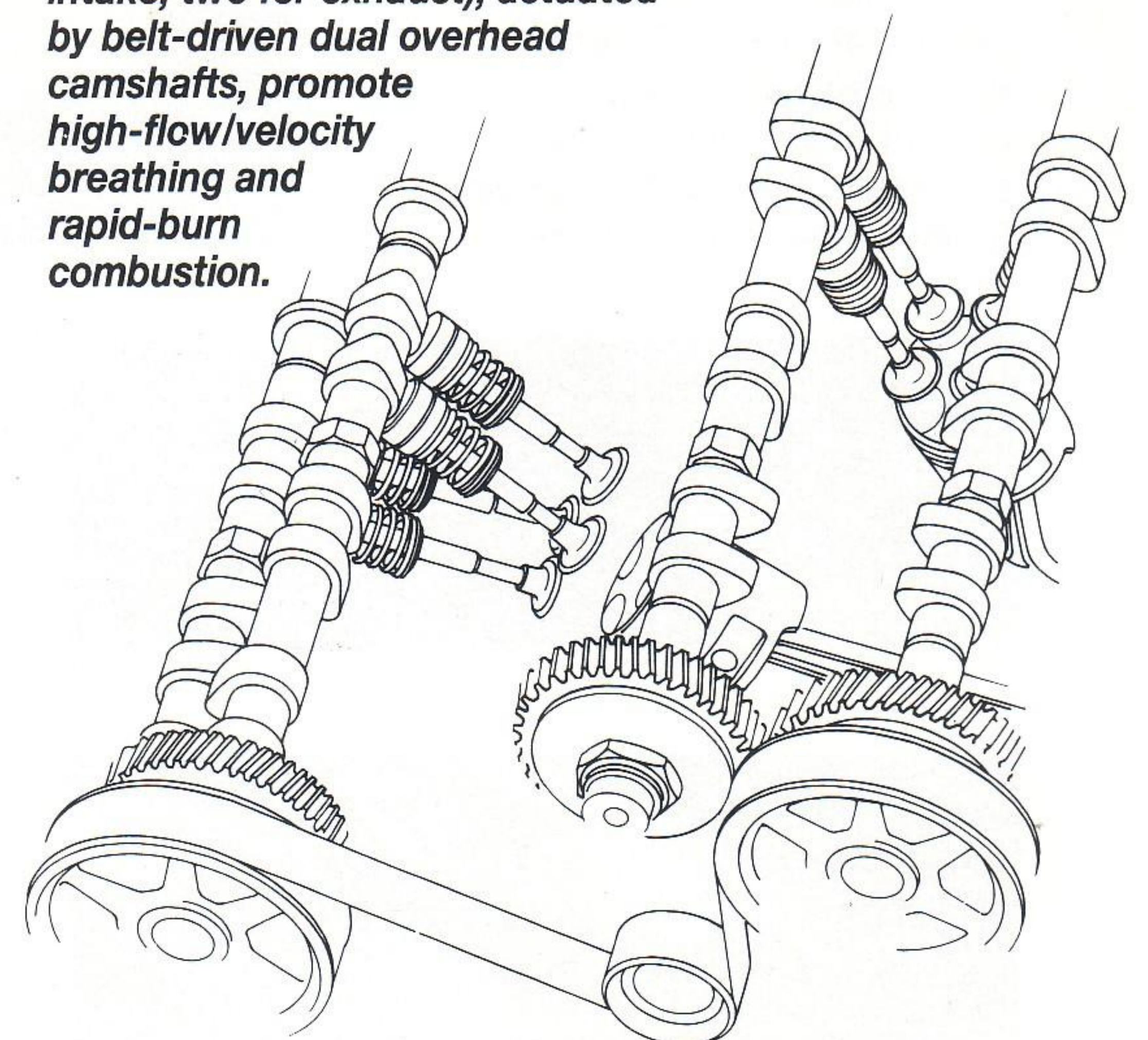

MAJOR STANDARD FEATURES

Probe

Concealed halogen headlamps
 Manual-adjustable outside mirrors (driver-side remote)
 Flush door handles
 Wraparound quarter windows with concealed centre and rear pillars and flush glass
 Tinted rear window and quarter window glass
 Functional roof drip molding
 Wheel covers
 Driver air bag Supplemental Restraint System (SRS)
 3-point active lap/shoulder safety belts front and rear
 Electronic AM/FM stereo radio, digital clock, 4 speakers
 Centre console with rear ashtray
 Side window demisters
 Performance instrument cluster with tachometer, fuel gauge, temperature gauge, oil pressure gauge, voltmeter, and trip odometer
 Urethane soft-feel steering wheel
 Front cloth bucket seats with integral headrests; recliners with memory feature
 Door trim panels with integral armrests
 50/50 fold-down rear seats
 Cargo compartment light
 Daytime running lights

Probe GT (in addition to or in place of standard features listed above)

Unique front and rear fascias
 Rectangular fog lamps
 Lower bodyside cladding
 16" 5-spoke aluminum wheels
 Full centre console with folding armrest, cup holder
 Leather-wrapped steering wheel and manual transaxle shift knob
 Driver seat power lumbar/seat back side bolster adjust
 Seat back stowage compartment
 Cargo area net

SPECIFICATIONS

Probe

16-valve, DOHC 2.0L I-4 with multi-port electronic fuel injection; 9.0:1 compression ratio; 5-speed manual overdrive transaxle (4.11:1 final drive ratio)
 115 horsepower (SAE net) @ 5500 rpm;
 124 lbs./ft. of torque (SAE net) @ 3500 rpm
 Front-wheel drive
 MacPherson strut 4-wheel independent suspension with stabilizer bars
 Power rack-and-pinion steering, 17.0:1 ratio overall
 Power front disc/rear drum brakes
 Unitized body construction with separate front subframe
 P195/65R14 89S black sidewall all-season radial tires
 Fuel capacity: 58 litres (12.8 gallons)

Probe GT (in addition to or in place of standard features listed above)

24-valve, DOHC 2.5L V-6 with multi-port electronic fuel injection; 9.2:1 compression ratio; 5-speed manual overdrive transaxle (4.39:1 final drive ratio)
 164 horsepower (SAE net) @ 6000 rpm;
 156 lbs./ft. of torque (SAE net) @ 4000 rpm
 Up-rated unique GT sport suspension
 Power 4-wheel disc brakes
 P225/50VR16 91V black sidewall performance radials

PREFERRED EQUIPMENT PACKAGES AND OPTIONS

P = Package feature (content subject to change)
 O = Optional feature S = Standard feature

	Probe		Probe GT	
	046A	047A	050A	051A
Appearance/Comfort/Convenience				
Dual electric remote-control mirrors	P	P	P	P
Tilt steering column	P	P	P	P
Convenience Group: tinted glass; variable-timed interval wipers; remote-control fuel door and liftgate releases; battery saver; convenience lights for door/liftgate ajar, low fuel, low washer fluid, glove box, engine compartment; plus fade-to-off dome lamp and headlamp warning chime	P	P	P	P
Manual air conditioning	O	P	P	P
Remote keyless entry system	O	P	O	P
Power Group: power windows with driver-side "express down" feature; power door locks; and door map pockets	O	P	O	P
Light Group: illuminated entry system; dual illuminated visor mirrors; fade-to-off dome lamp with map lights	O	P	O	P
Colour-keyed bodyside moldings	O	P	O	P
Speed control	O	P	O	P
Rear wiper/washer and heated electric remote mirrors	O	O	O	P
Console with storage bin, armrest, and cupholder	O	O	S	S
Manual driver's seat height adjustment	O	O	O	O
6-way power driver's seat adjustment	O	O	O	O
Colour-keyed front floor mats	O	O	O	O
Power sliding roof (includes map lights in an overhead console)	O	O	O	O
15" aluminum wheels and P205/55R15 87S radial tires	O	O	-	-
Seats				
GT cloth bucket seats, GT door trim and instrument panel accent stripe, and cargo net	O	O	S	S
Leather seating surfaces (on Probe model, requires optional GT bucket seats and 6-way power driver's seat adjustment)	O*	O*	O*	O*
Stereo Systems				
Electronic AM/FM stereo radio with cassette player and premium sound system	P	P	P	P
Compact disc player with electronic AM/FM stereo radio and premium sound system	O	O	O	O
Graphic equalizer	O	O	O	O
Power antenna	O	O	O	O
Radio credit option (deletes standard AM/FM stereo radio)	O	-	-	-
Performance				
Electronic 4-speed automatic transaxle	O	O	O	O
Anti-lock brake system (includes 4-wheel disc brakes and sport suspension in Probe model)	O	O	O*	P

*See your Ford Dealer about delayed availability.

PROBE PAINT AND TRIM COLOURS

Exterior Paint Colours	Interior Trim Colours			
	Opal Grey	Royal Blue	Ruby Red	Black
Vibrant White*	•	•	•	•
Black	•	•	•	•
Rio Red (tinted non-metallic) Clearcoat	•	•	•	•
Electric Red Clearcoat Metallic*	•	•	•	•
Bimini Blue Clearcoat Metallic	•	•	•	•
Steel Blue Frost Clearcoat Metallic*	•	•	•	•
Electric Blue Clearcoat Metallic*	•	•	•	•
Bright Yellow (tinted non-metallic) Clearcoat*(1)	•	•	•	•
Bright Caypso Green Clearcoat Metallic	•	•	•	•
Silver Clearcoat Metallic*	•	•	•	•

*New for 1993 (1) Late availability for Probe.

PRODUCT CHANGES

Following publication of the catalogue, certain changes in standard equipment, options, prices and the like, or product delays, may have occurred which would not be included in these pages. Your Ford Dealer is your best source for up-to-date information.

Ford of Canada reserves the right to change product specifications at any time without incurring obligations.

PROBE EQUIPMENT

The all-new Probe is designed and equipped for driving enjoyment. And great value, too.

In addition to Probe's standard features, there are Preferred Equipment Packages which offer a savings on the options included. Compared with the prices of the items if they were purchased separately, the discounts are equivalent to getting certain equipment at no extra charge.

To further personalize your Probe, choose from the list of optional features available separately.

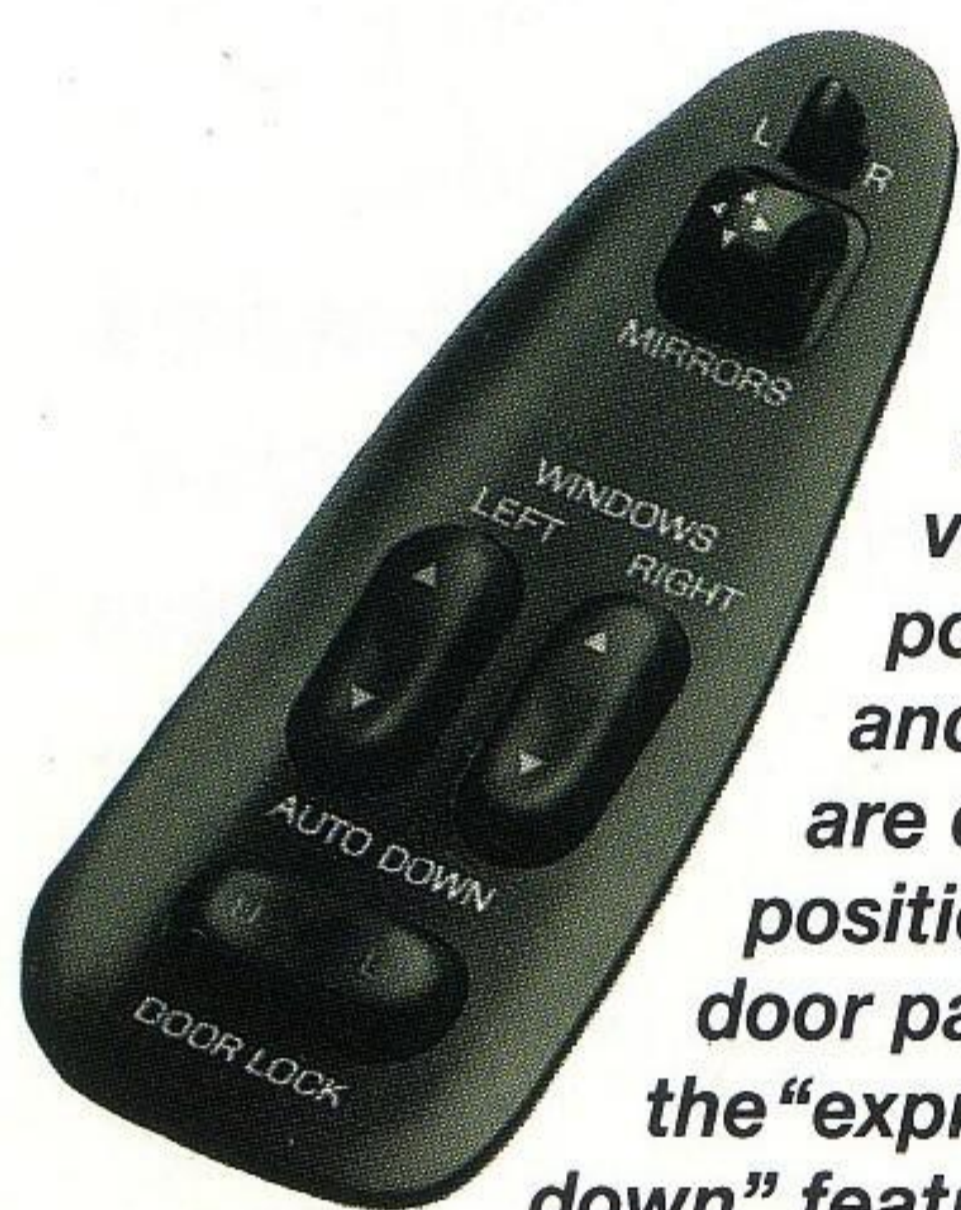

Controls for the optional electric rear-view mirrors, power windows and door locks are conveniently positioned on the door panel. With the "express-down" feature, the driver can lower either window at the touch of the button. From the outside, one or both doors can be unlocked with a turn of the

Below: The optional electronic AM/FM stereo radio with cassette player and premium sound system. And the new all-electronic 7-band graphic equalizer with five pre-set memories (classical, pop, rock, vocal and jazz) and other outstanding features.



Optional speed controls are located on the steering wheel for fingertip convenience.



Let in more sunshine and fresh air with the new power sliding roof option.

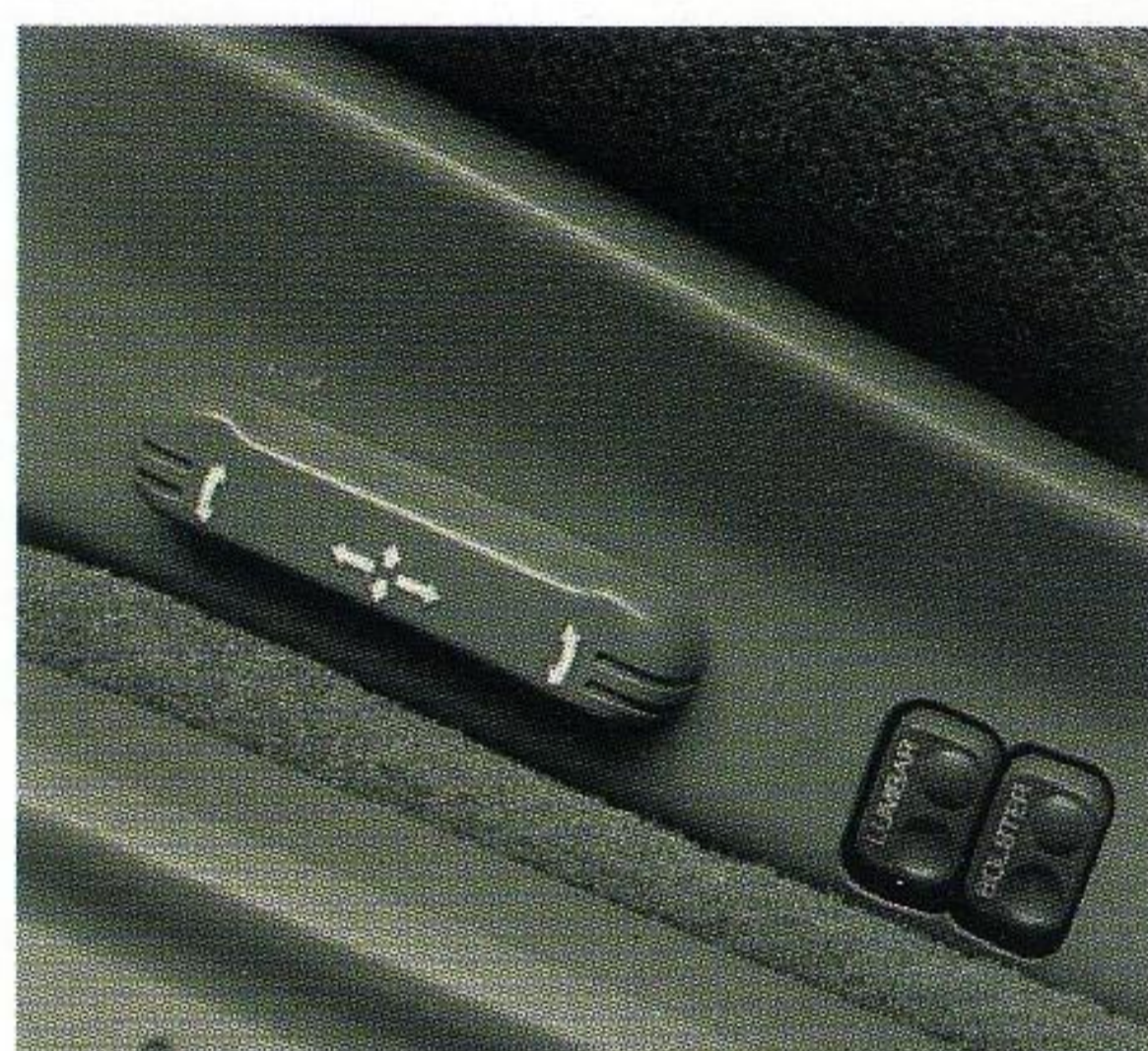
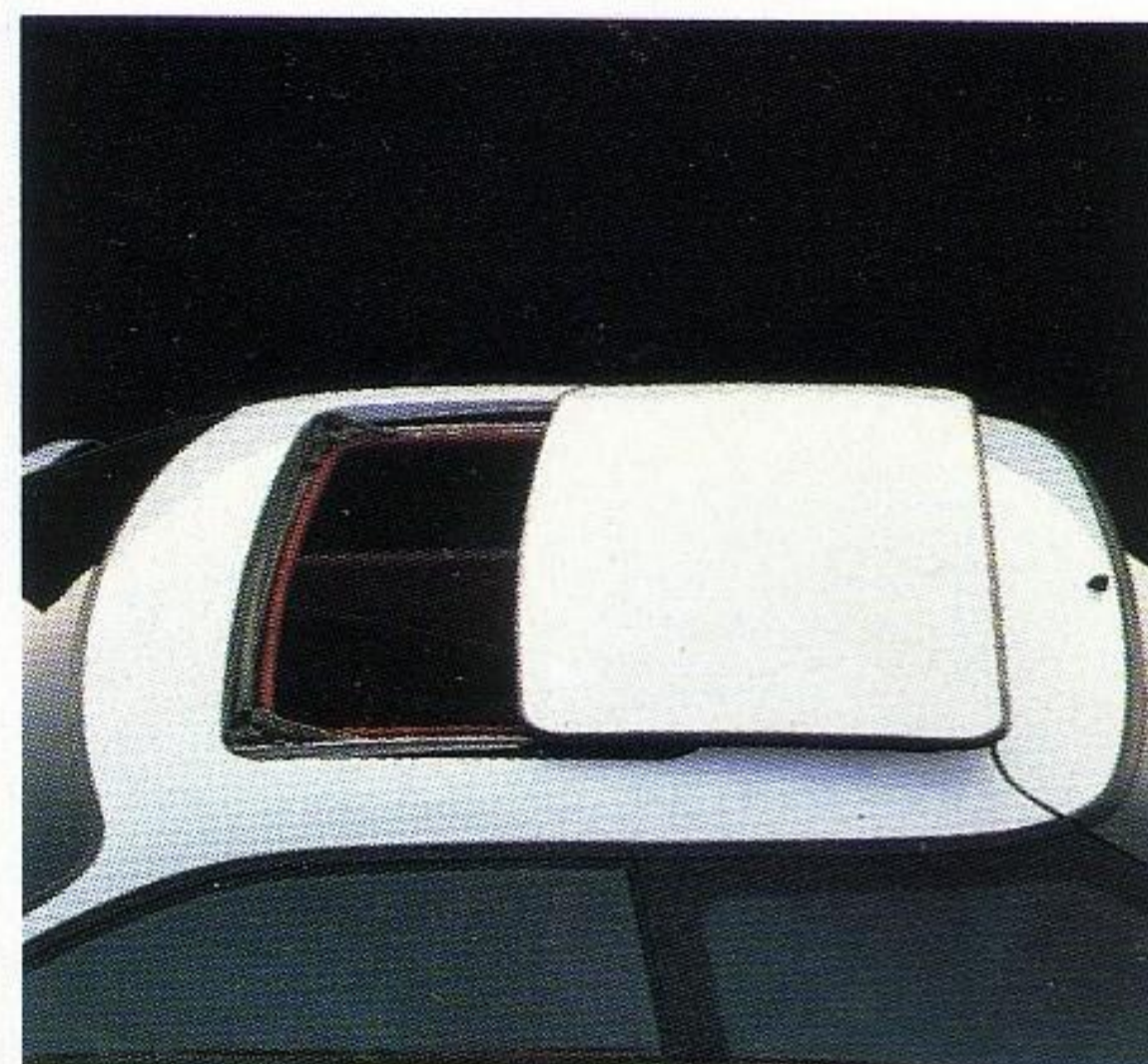

With a single control, you can adjust the optional power driver's seat forward/back, up/down, and tilt forward/back.

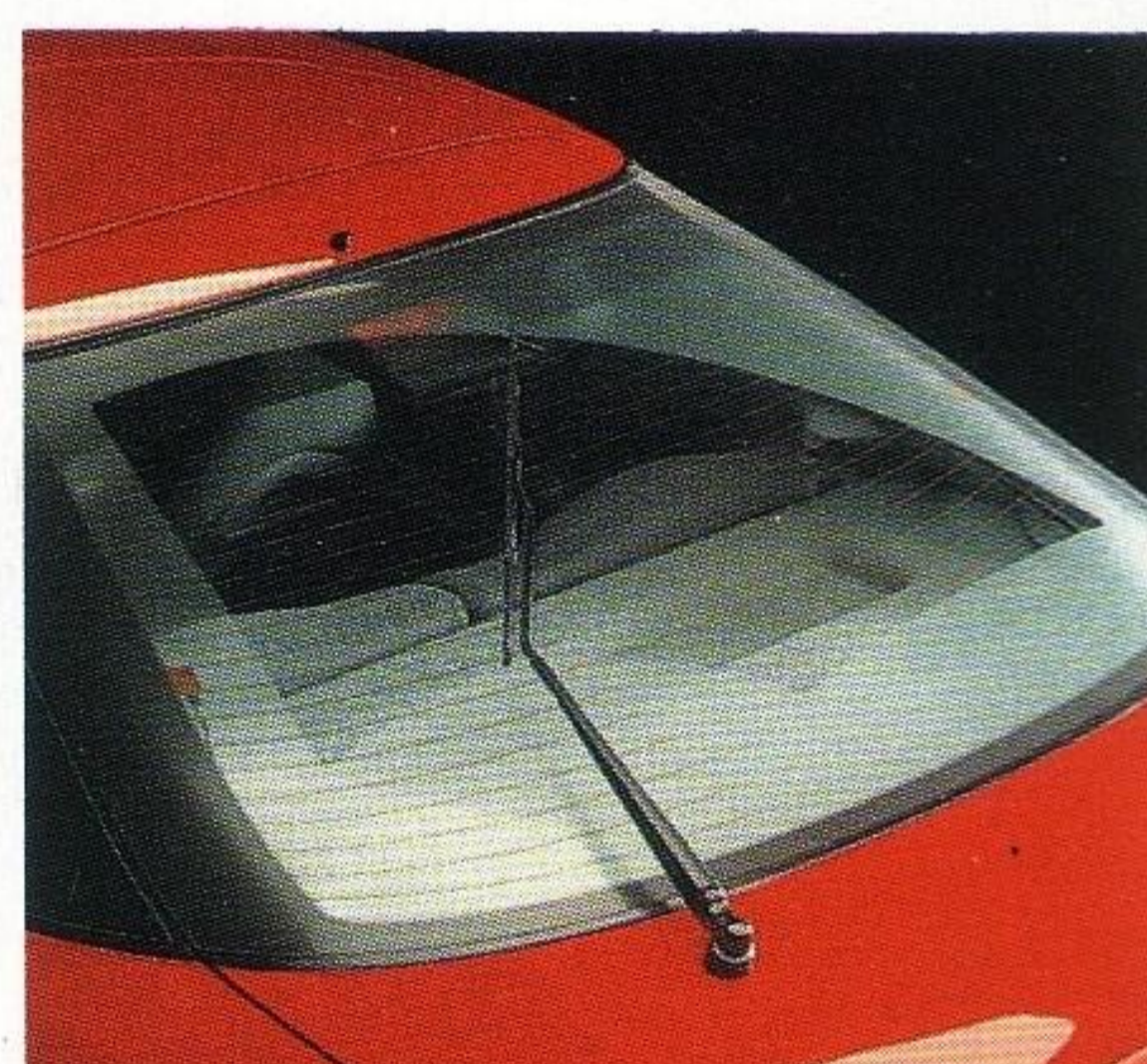

Enhance rearview vision year-round with the optional rear wiper/washer and electric "heated" remote mirrors.

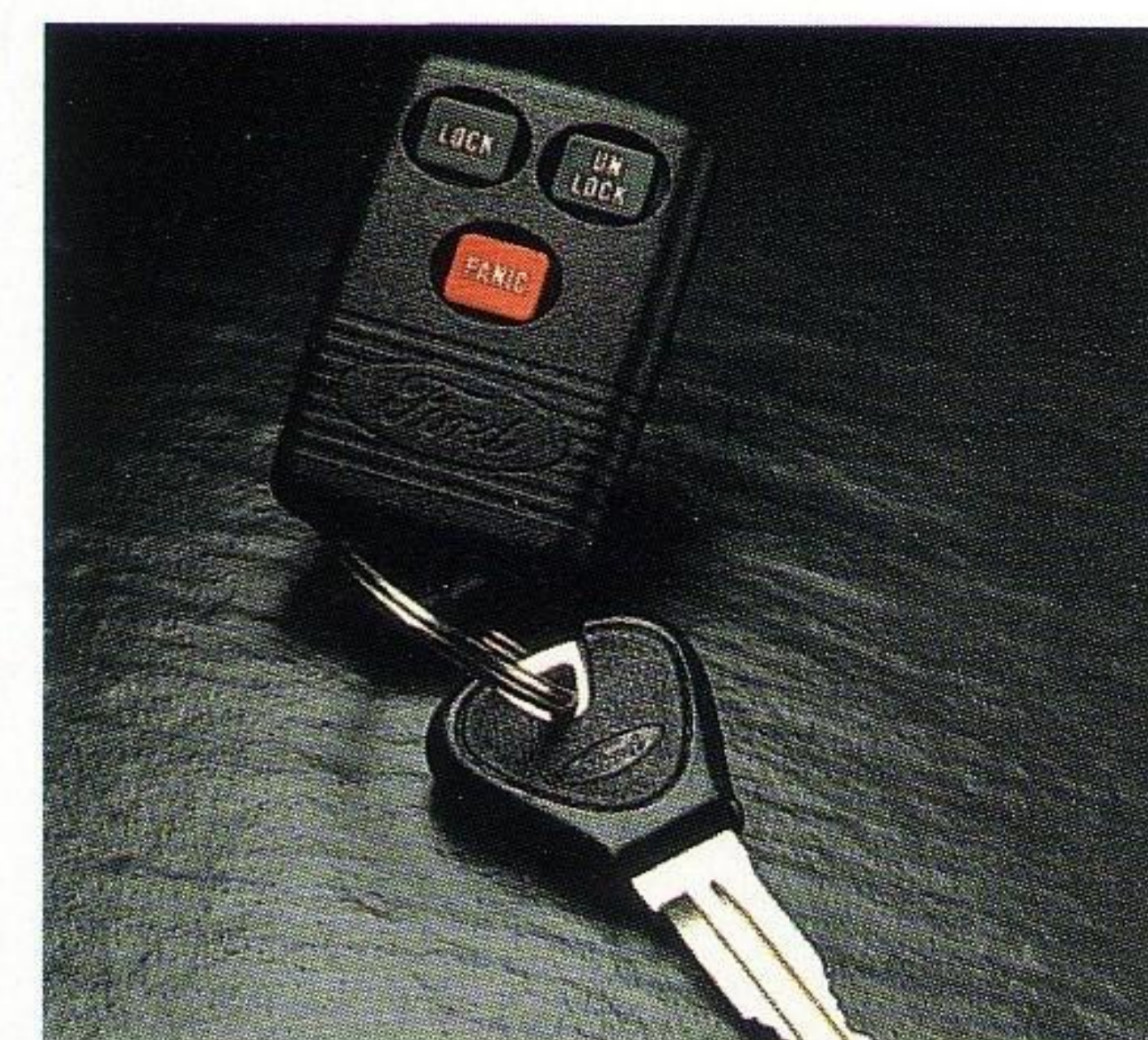

For added security, available in the '93 Probe is the new remote keyless entry system.

The optional 4-speed automatic transaxle is electronically governed for smooth and precise shifts. Includes driver-activated 4th gear overdrive lockout feature.

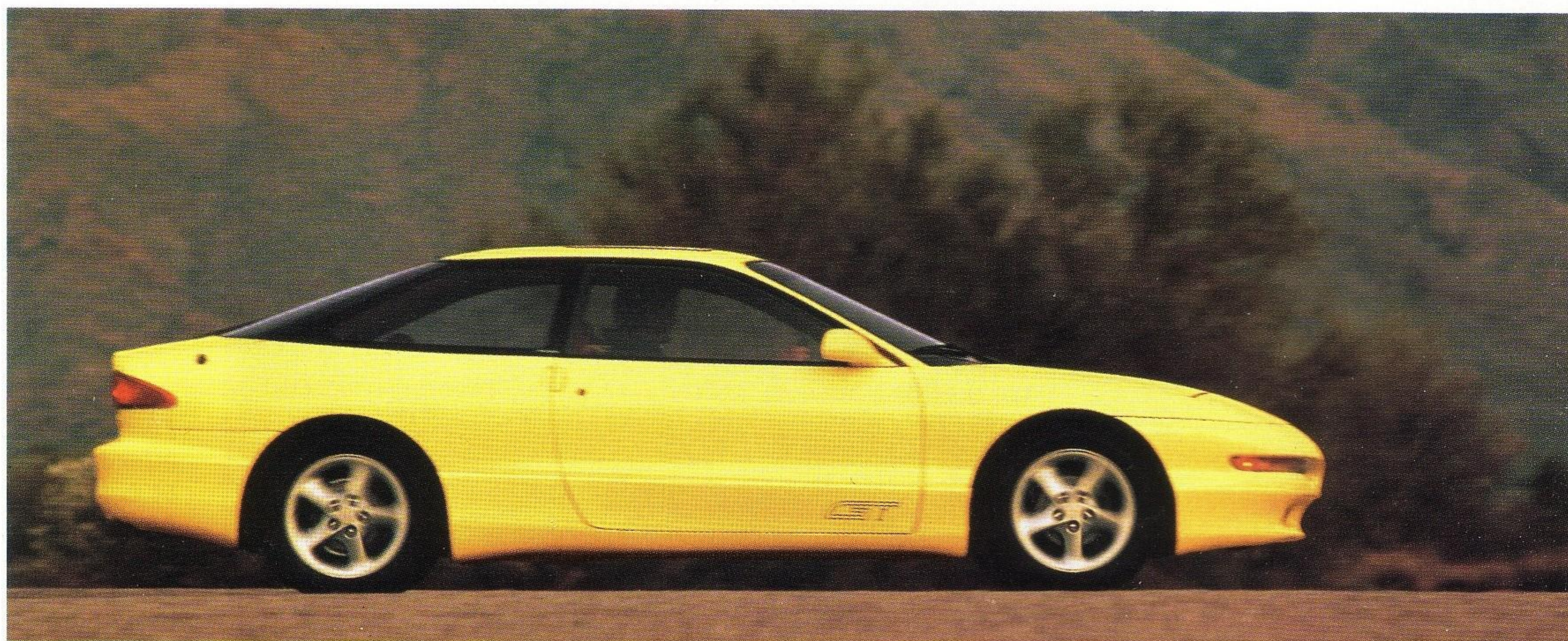

Above: The optional 4-wheel disc anti-lock brake system helps provide more steering control and shorter, straighter stops under most driving conditions.



From left to right: 14" wheel cover (standard in Probe); 15" 3-spoke aluminum wheel (optional in Probe), and 16" 5-spoke aluminum wheel (standard in Probe GT).