

THIS IS A STORY OF COURAGE

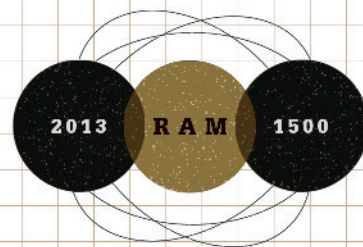

PAGE 1
1500

PAGE 2
1500

GUTS

This is a story of courage. Of a team of men and women who set out to build the truck they always wanted to build.

Who resolved to craft without compromise.

To forge intelligence into steel.

To make the efficient, magnificent.

To merge the economical and the powerful.

Who resolved to stick out their necks when no one else would and challenge every truck convention.

This is the story of how the entire team at the Ram truck brand moved Heaven and Earth to build the Ram 1500, *Motor Trend's* 2013 Truck of the Year.®

PAGE 3
1500

GLORY

THE NEW 2013 RAM 1500

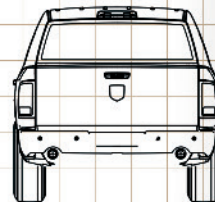
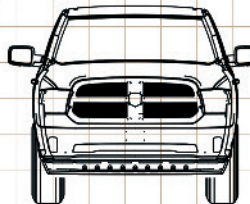
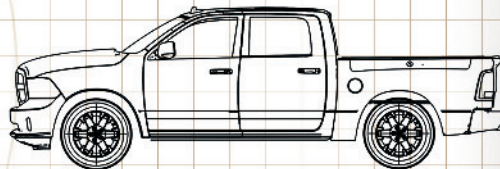

And this is only the first chapter.

PAGE 4
1500

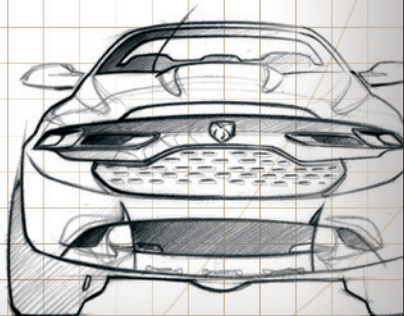
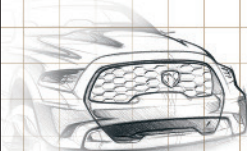
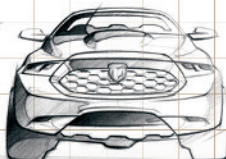
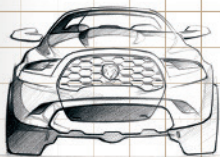
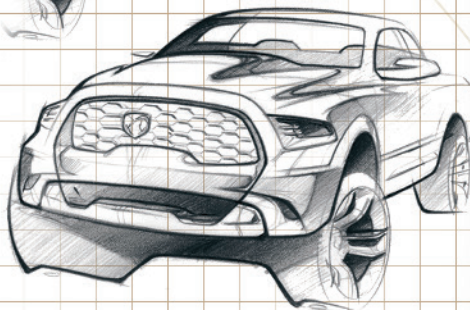
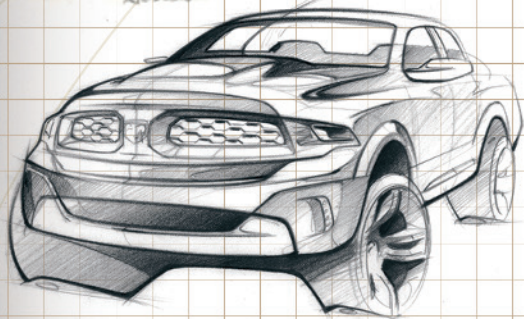
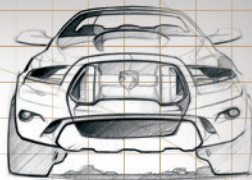
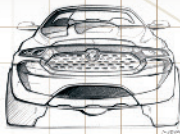
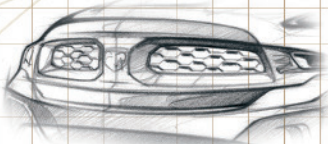

Ram sought great ideas across disciplines,
departments, and industries. They filled
walls with ideas and studios with sketches.
They built virtual models and broke
traditional molds. Evaluated costs and
argued with diehards. But most important,
they got behind the wheel.

**AND FOR EACH NEW
QUESTION THAT WAS
POSED, THEY HAD THE
COURAGE
TO ANSWER YES
WHEN THEY COULD
HAVE SAID NO.**

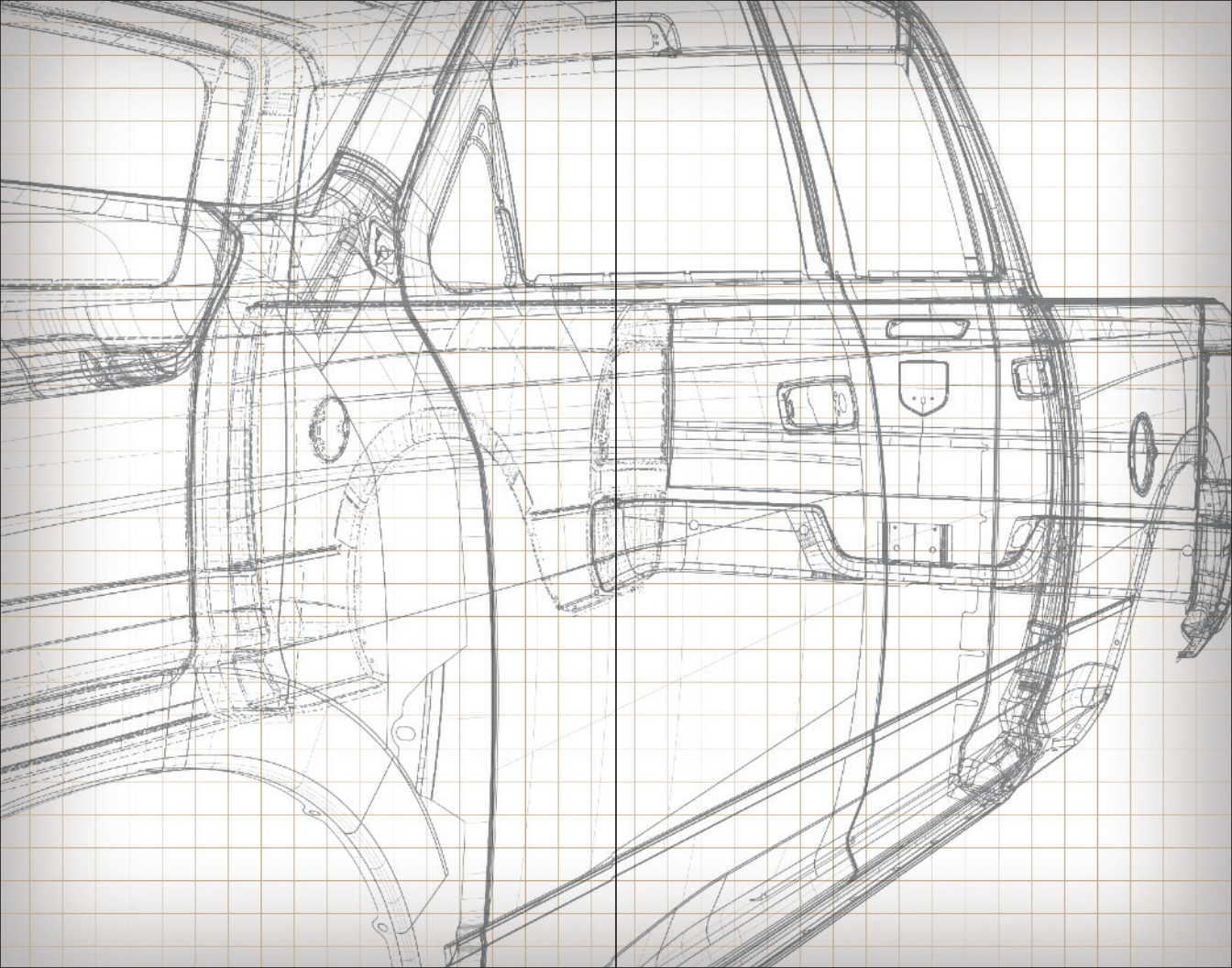

CAN WE BREAK THE MPG BARRIER?



The new 2013 Ram 1500 offers best-in-class highway fuel economy and one of the best engines on the road, the acclaimed 3.6L Pentastar® V6. When paired with the TorqueFlite™ 8 eight-speed automatic transmission, this Ram achieves an unmatched combination of capability with an EPA estimated 18 city/20 combined/25 highway MPG. It's also available with the legendary 5.7L HEMI® V8 with Fuel Saver Technology for nearly 20 percent better fuel economy compared with previous Ram V8 models.

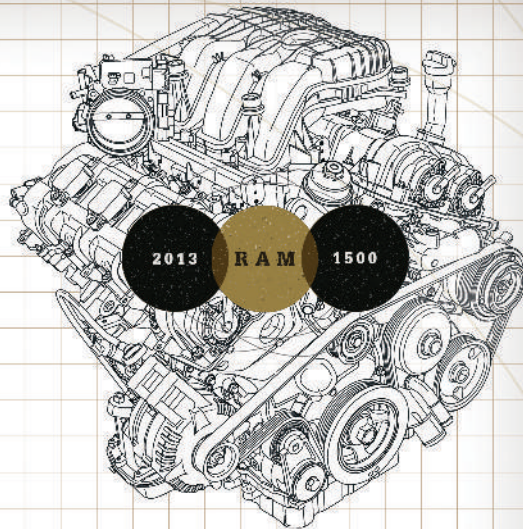

PENTASTAR V6 WITH EIGHT-SPEED TORQUEFLITE TRANSMISSION

CAN WE REVOLUTIONIZE THE RIDE? CAN WE REINVENT THE ROAD? CAN WE LIGHTEN EVERY LOAD?



The available class-exclusive Active Level™ air suspension of the 2013 Ram 1500 offers four drive modes for a smooth ride on and off the road,

AIR SUSPENSION

automatic load leveling, increased ground clearance, and driver-activated key-fob control for ease entering and loading the truck.

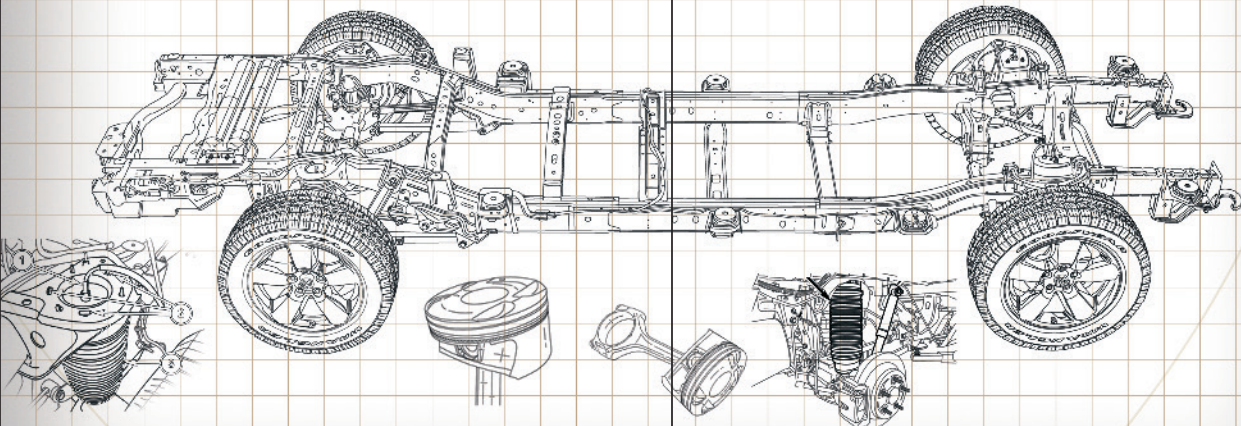

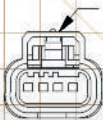
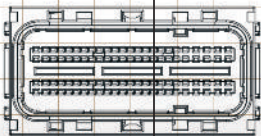
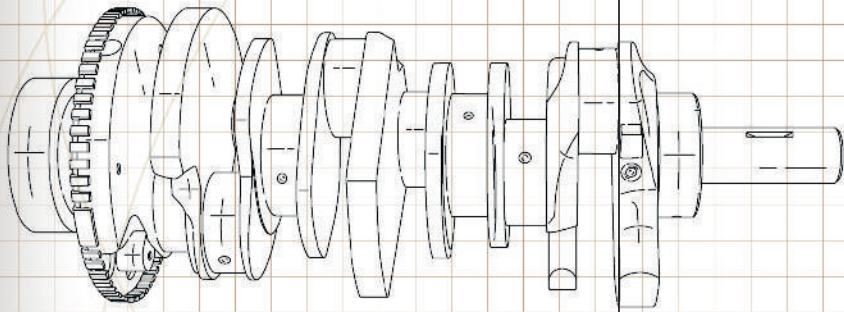
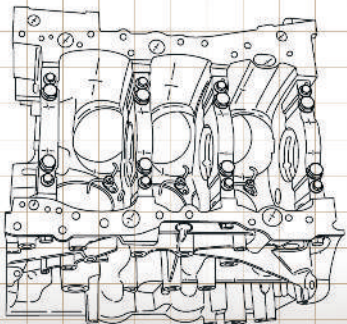
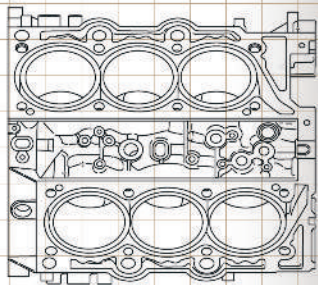
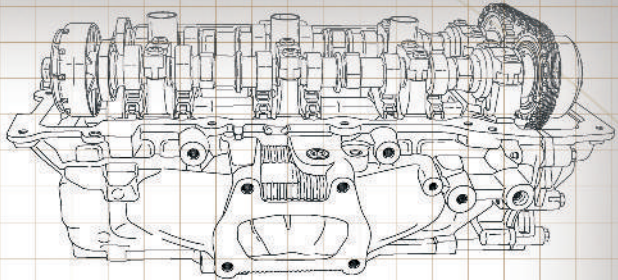

CAN WE HARNESS THE WIND? CAN WE ADVANCE AERODYNAMICS? CAN WE INCREASE OUR LEAD?

✓ **YES**

The 2013 Ram 1500 is the first truck with an active grille shutter system that automatically opens or closes to cool the engine, improve aerodynamics, and boost fuel efficiency—all while maintaining power, torque, and towing capabilities.

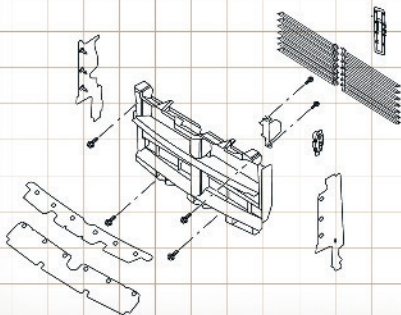

PAGE 15
1500

ACTIVE GRILLE SHUTTERS

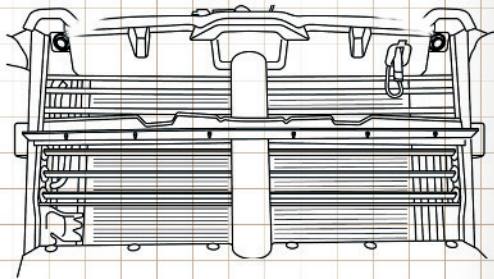

PAGE 16
1500

CAN WE SHIFT THE PARADIGM? CAN WE BOOST EFFICIENCY? CAN WE SET A NEW COURSE?

✓ **YES**

The revolutionary rotary shifter is the first of its kind in any light duty truck. This cutting-edge, dash-mounted design operates the 2013 Ram 1500's powerful Pentastar V6 and fuel-saving eight-speed transmission while saving space and enhancing responsiveness. Execute maneuvers like blind-shift transitions from reverse to drive when towing or navigating out of mud, snow, or active worksites with the ease and confidence of class-exclusive technology.

ROTARY SHIFTER

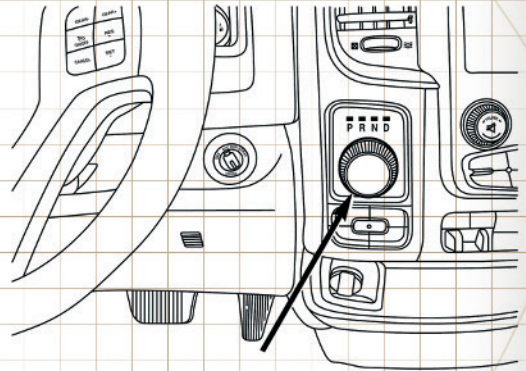

CAN WE PUT THE DRIVER IN THE DRIVER'S SEAT?

✓ **YES**

The 2013 Ram 1500 Uconnect® driver command system is a next-generation multimedia vehicle intelligence center, offering an 8.4" color touchscreen with Wi-Fi, emergency assistance, voice recognition, 3-D navigation, and SiriusXM™ satellite radio. Uconnect also includes an available state-of-the-art 7" EVIC screen with customizable real-time truck diagnostics, productivity, performance, and fuel economy information.

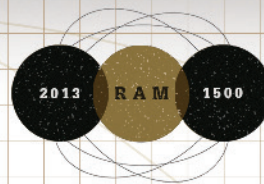

U-CONNECT®

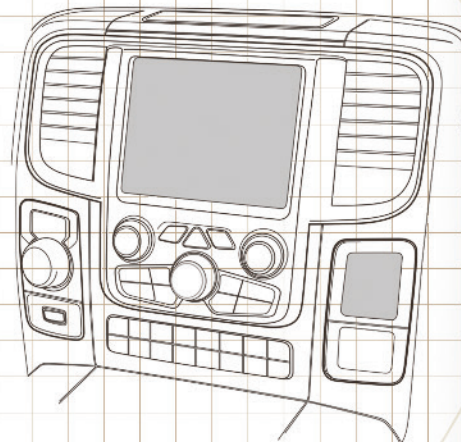

From the powertrain to the interior design,
the 2013 Ram 1500 is an achievement of
pioneering technologies united into one
hardworking, hard-driving system. With
the blood and sweat of every Ram designer
and engineer pulsing through its wiring,
it's everything that made last year's Ram
1500 great, evolved into an even smarter,
stronger, more powerful machine. No wonder
it was awarded the 2013 *Motor Trend*
Truck of the Year.®

THE NEW 2013 RAM 1500



ENGINEERED TO MOVE HEAVEN AND EARTH.

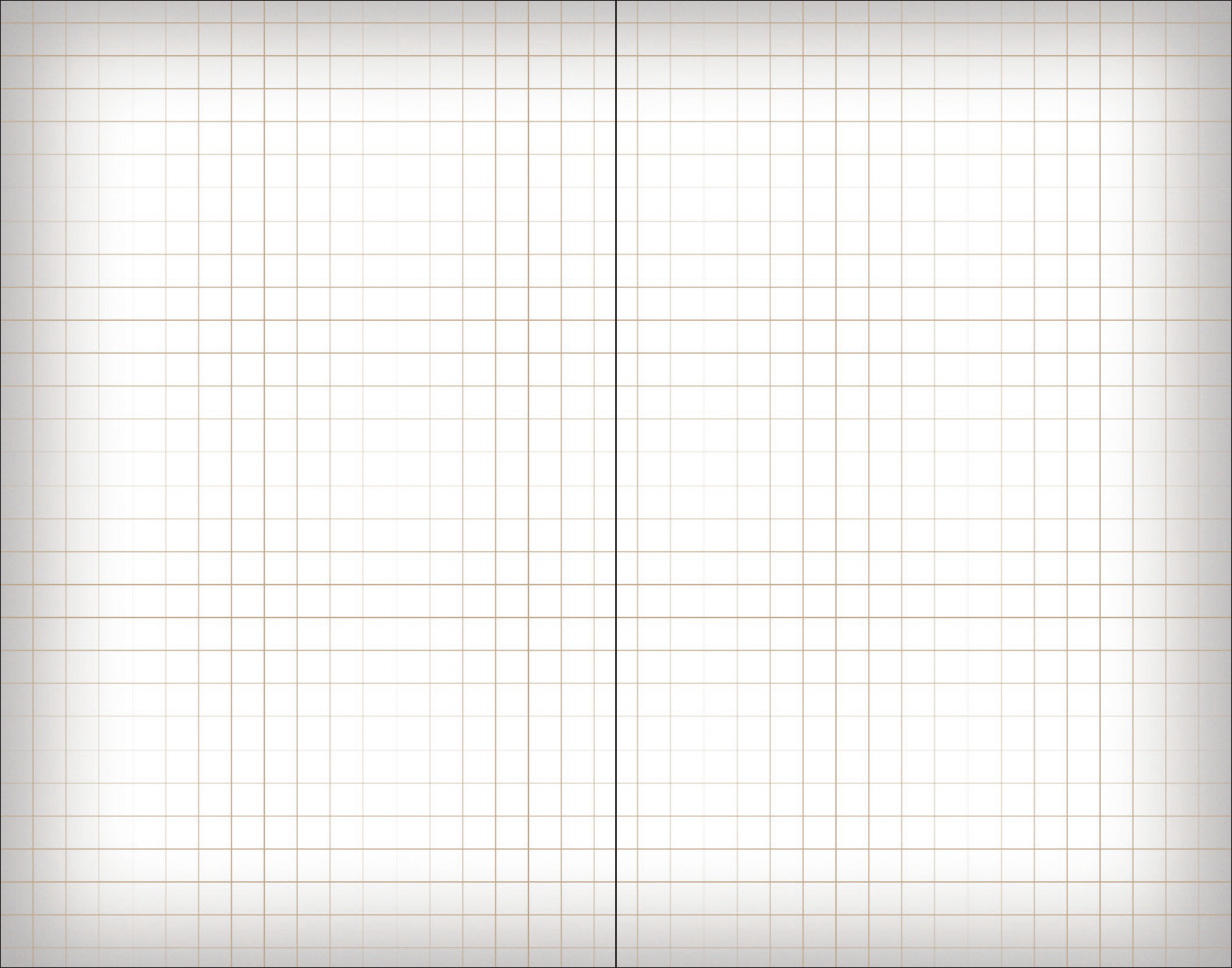

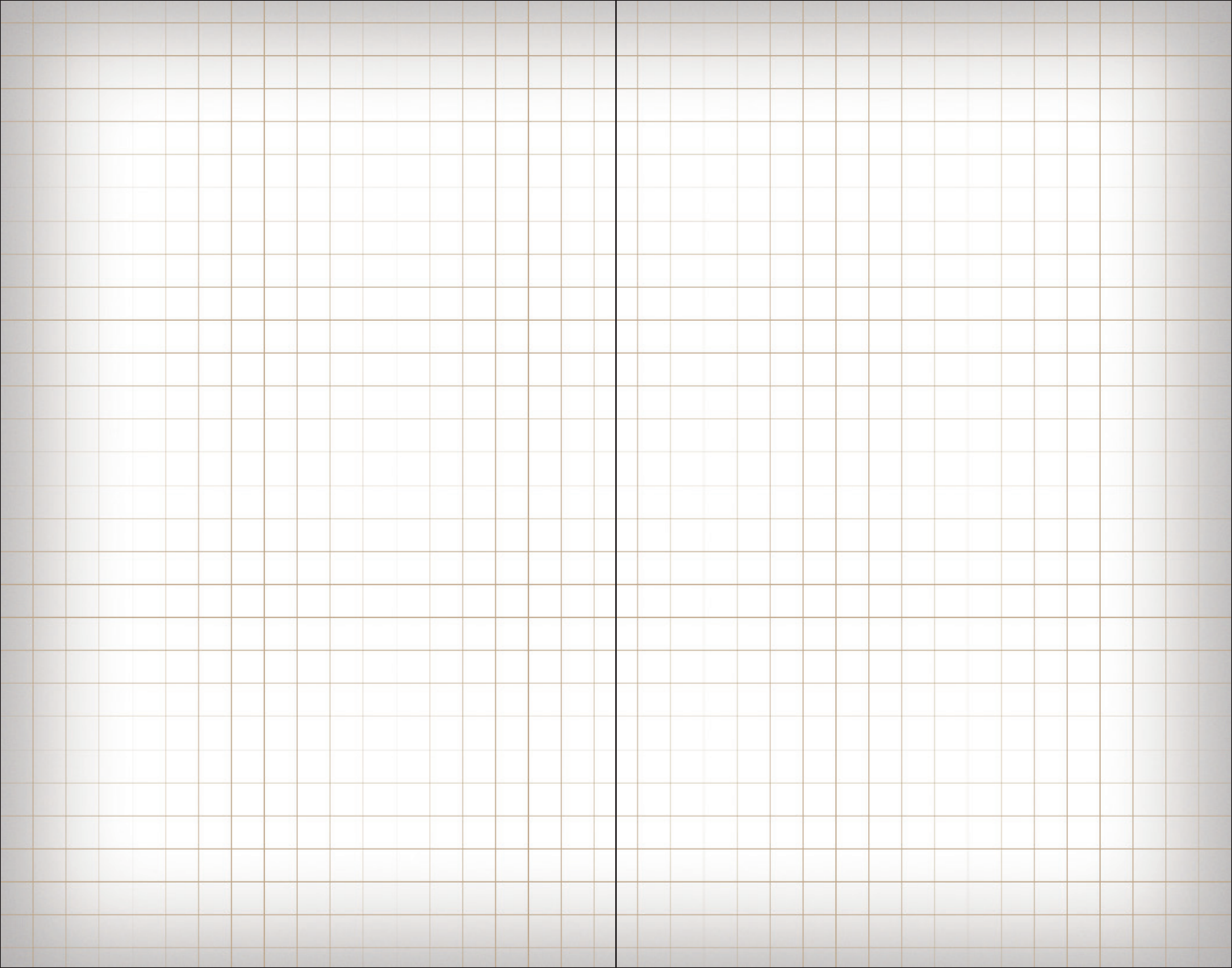

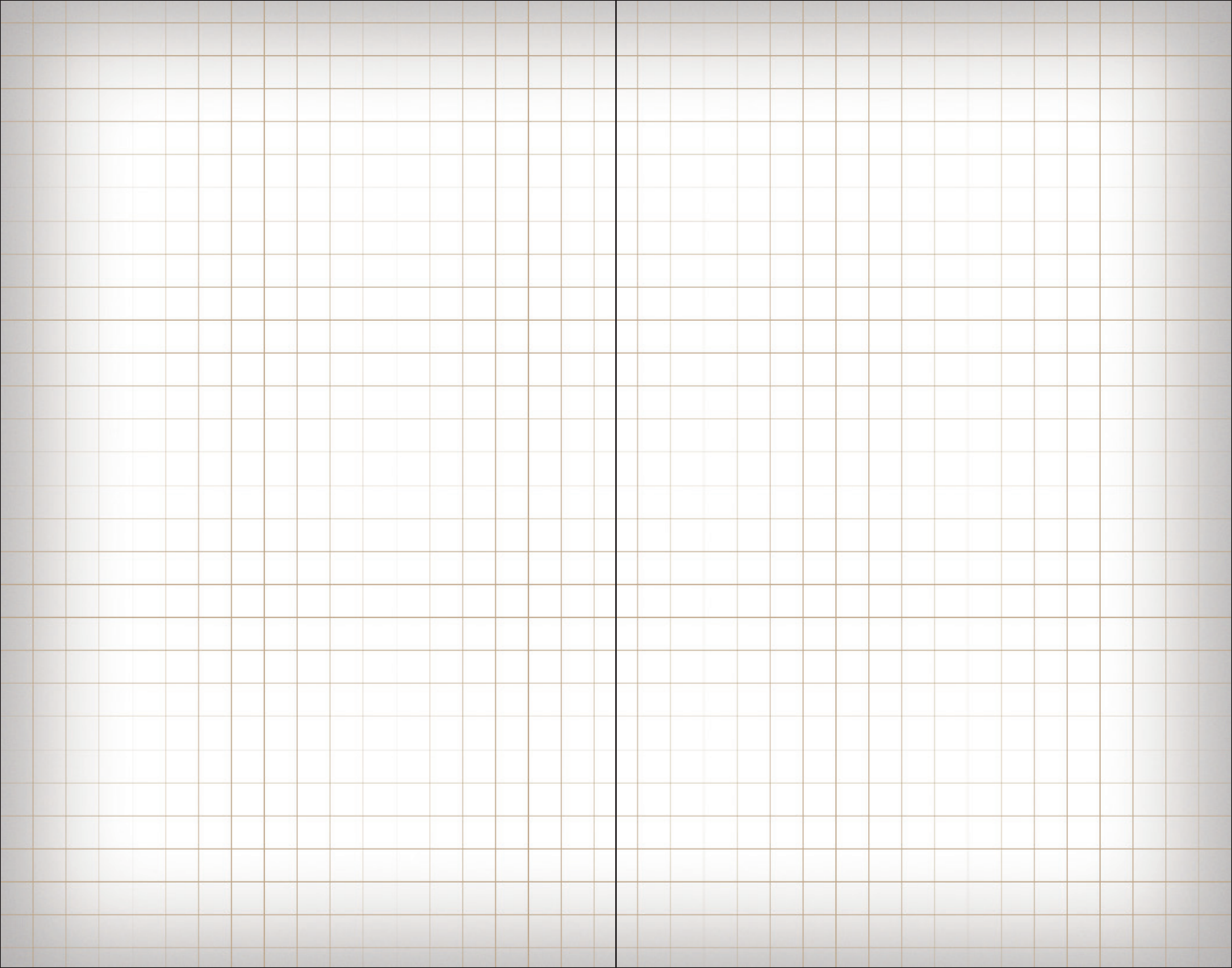

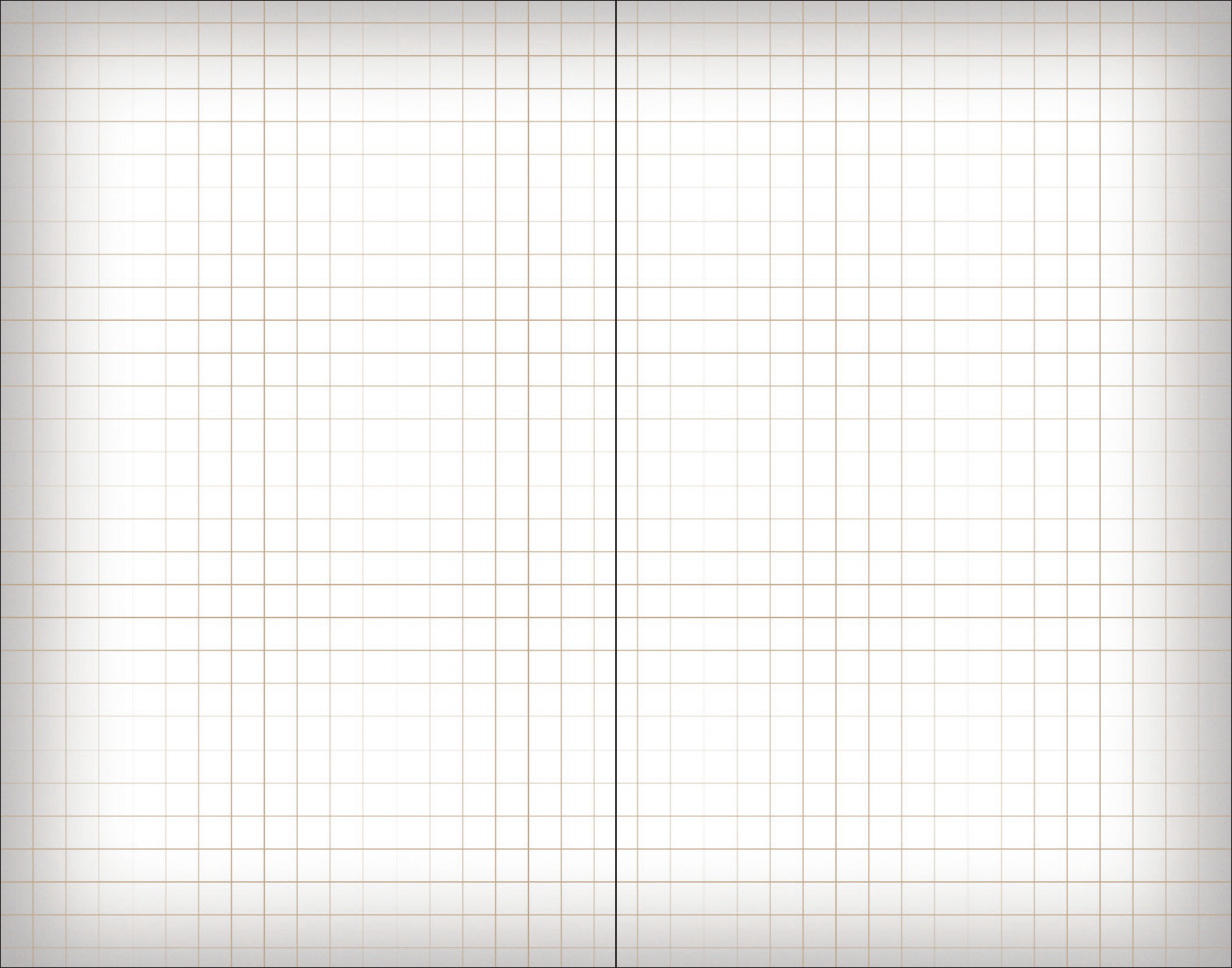

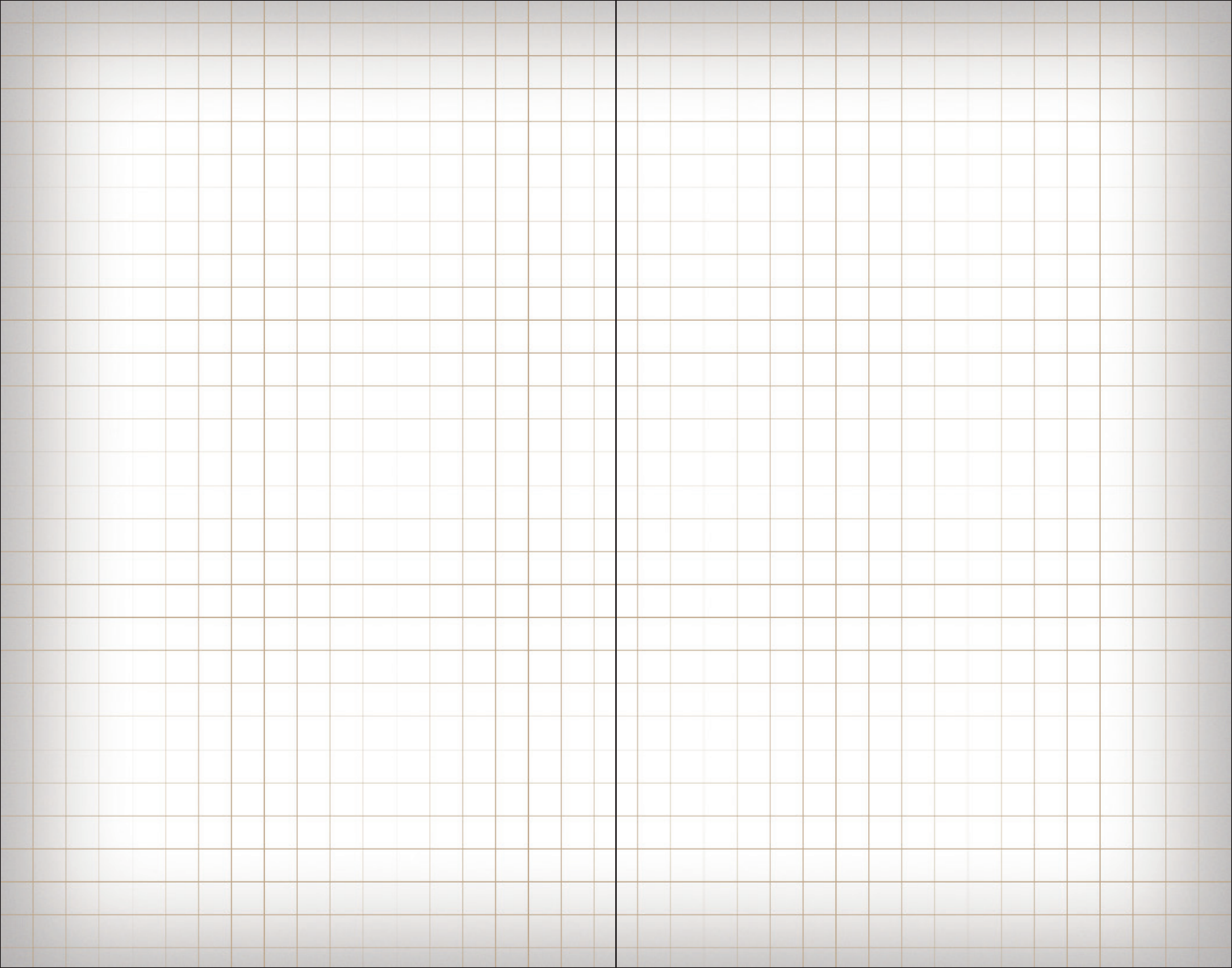

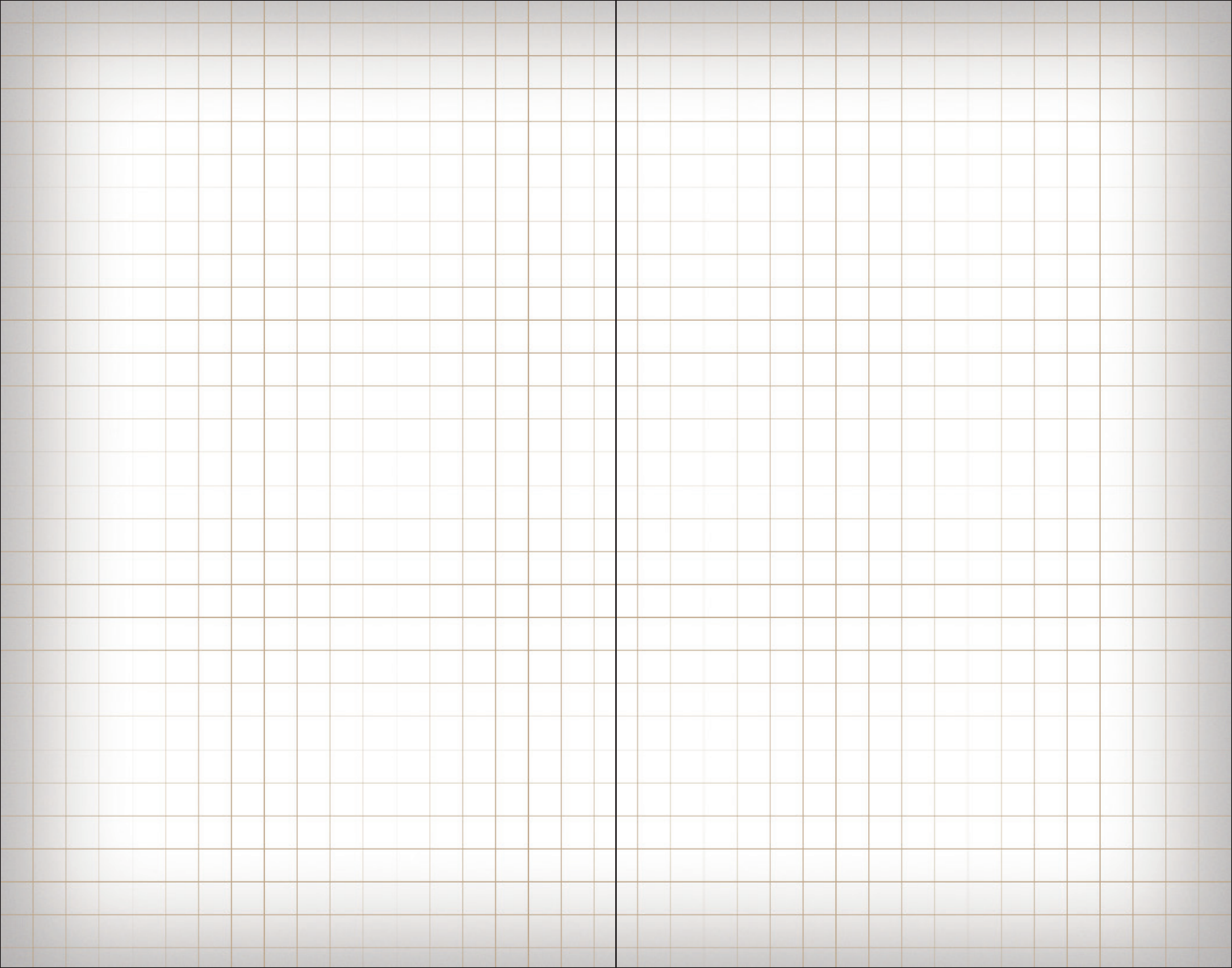

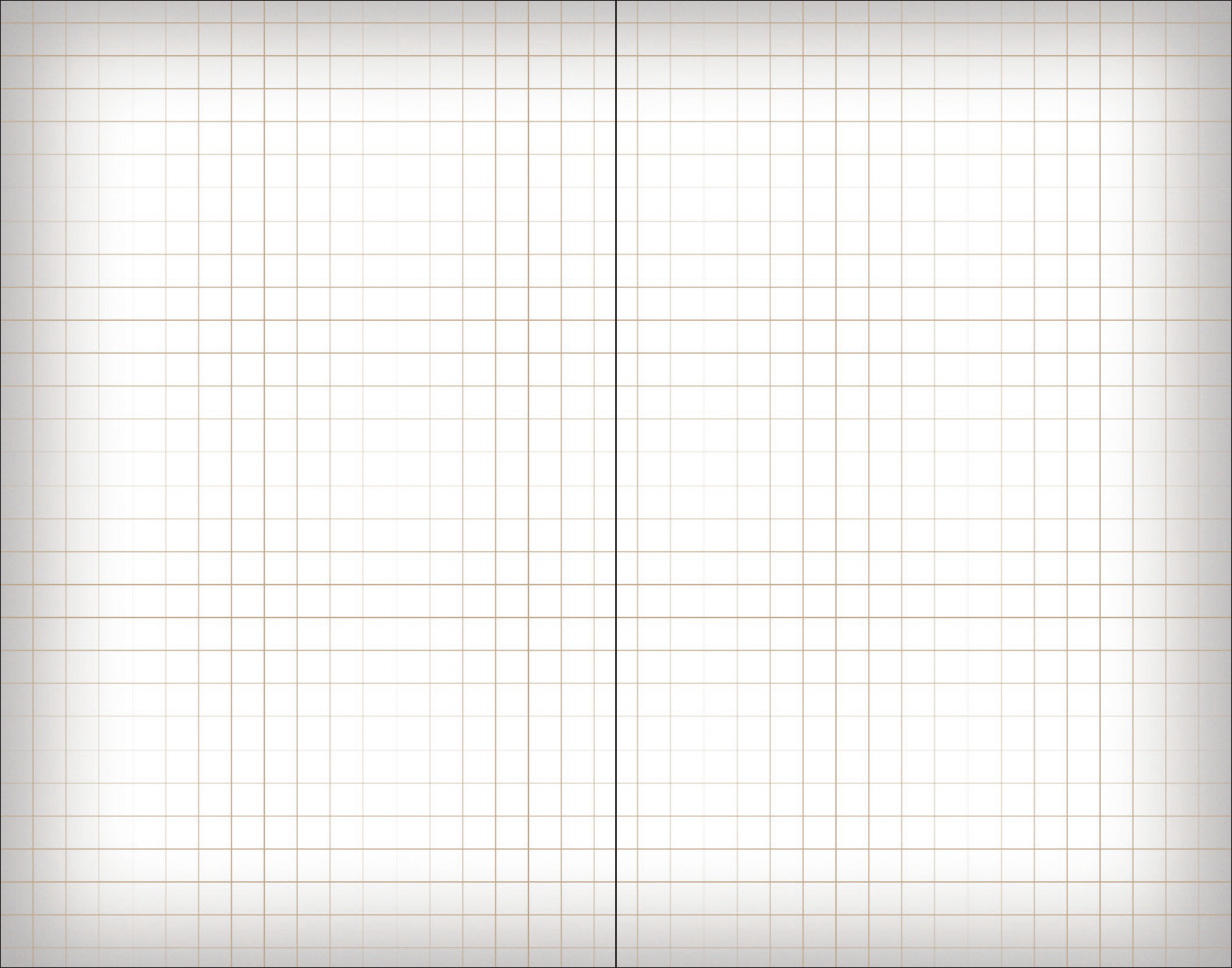

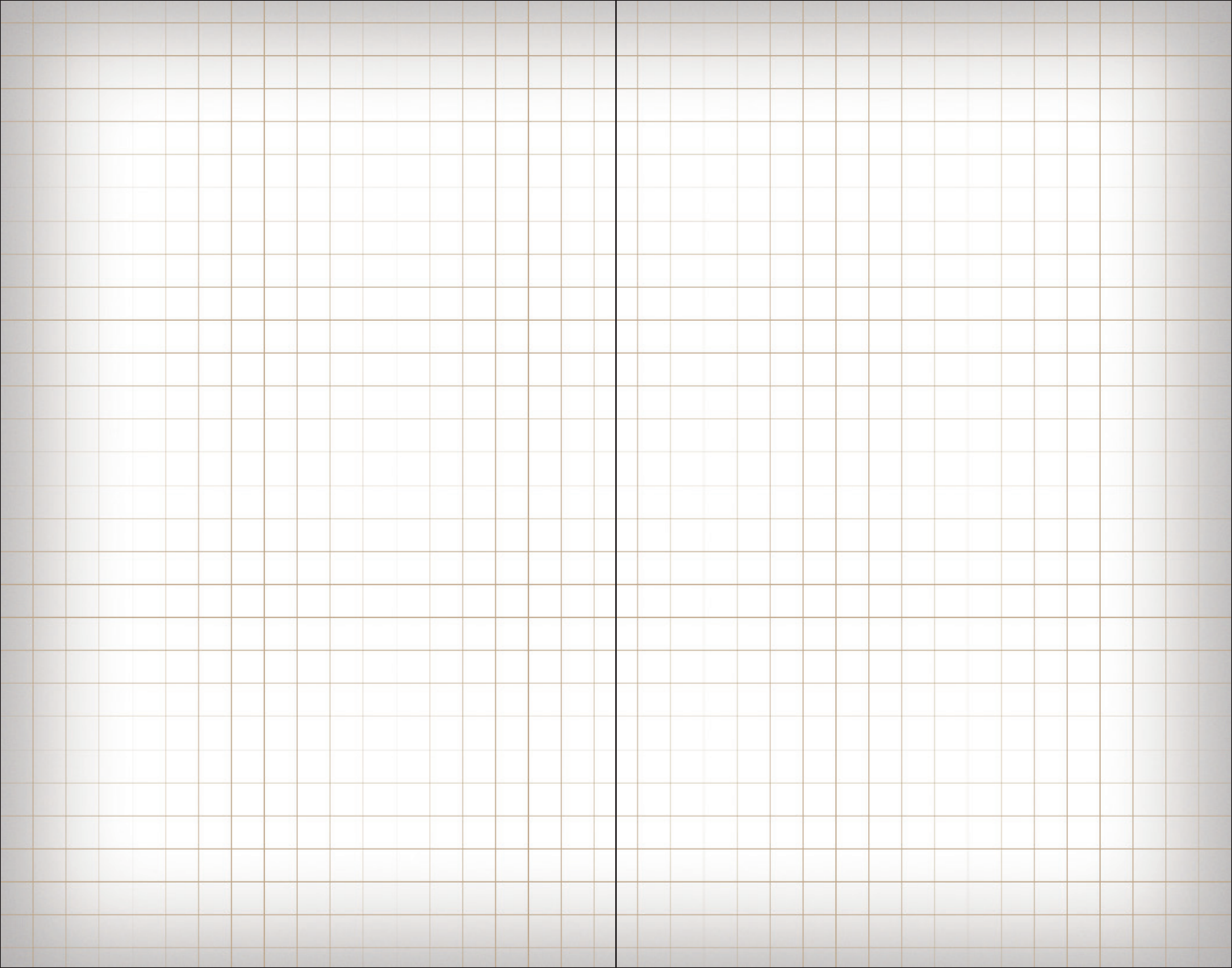

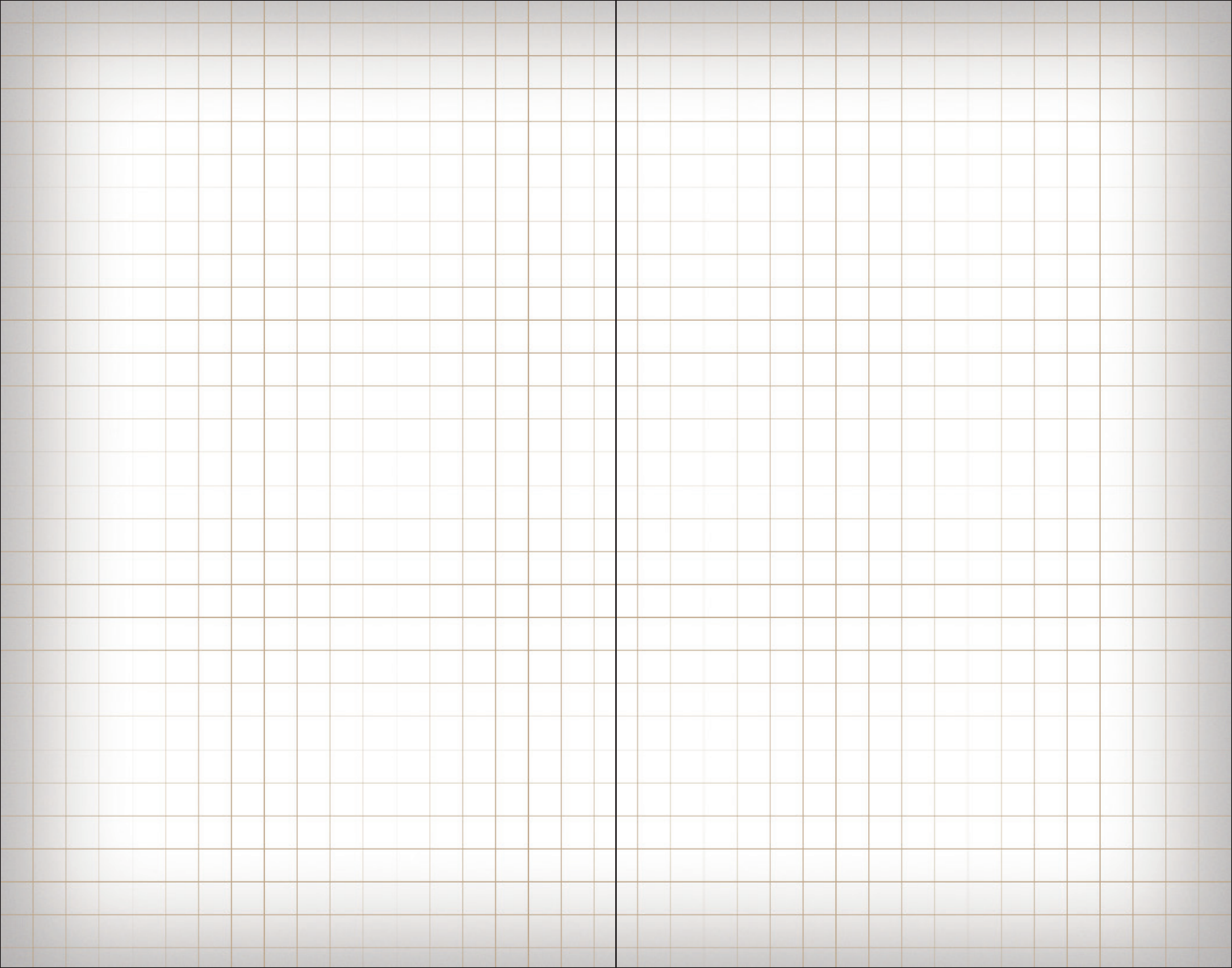

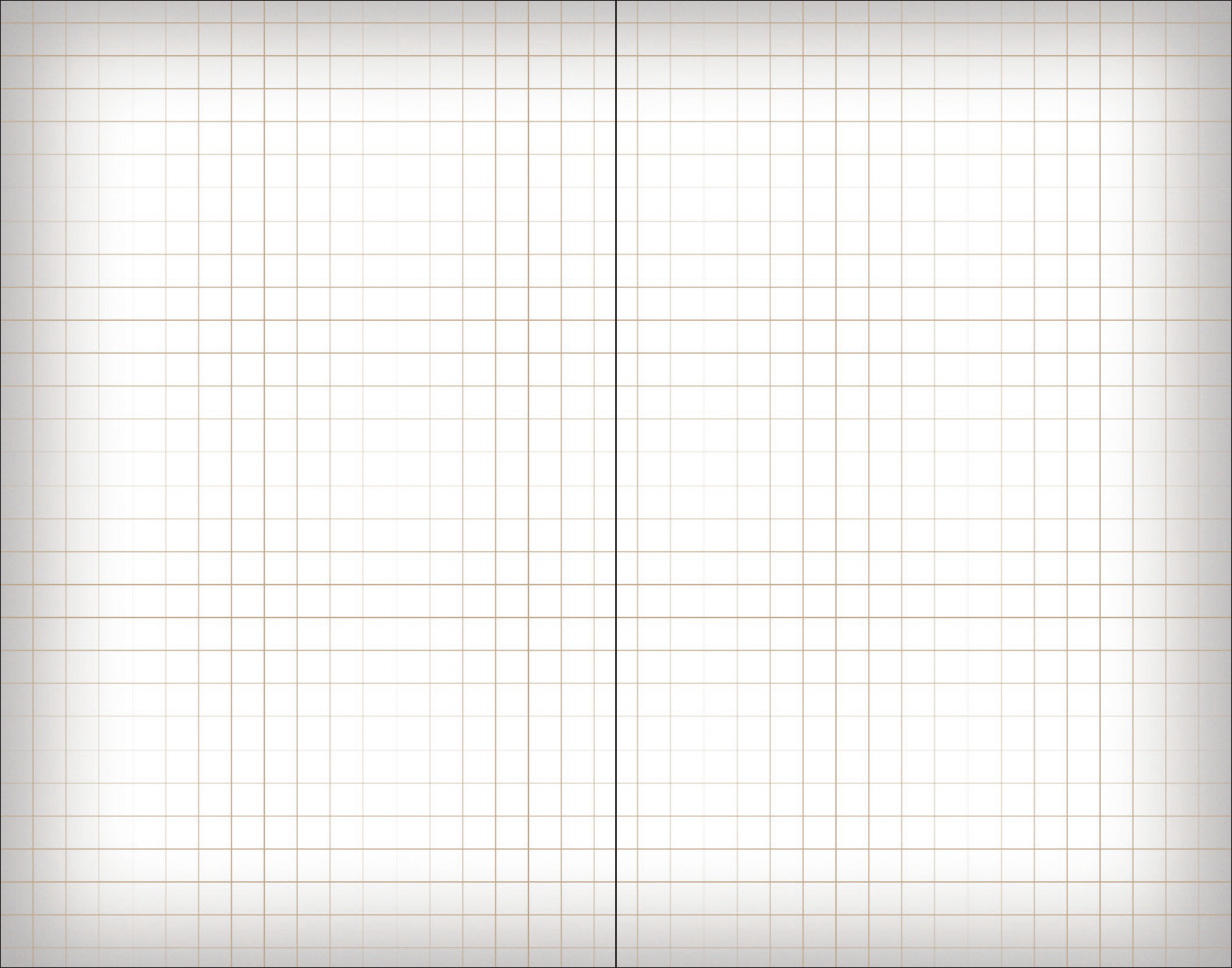

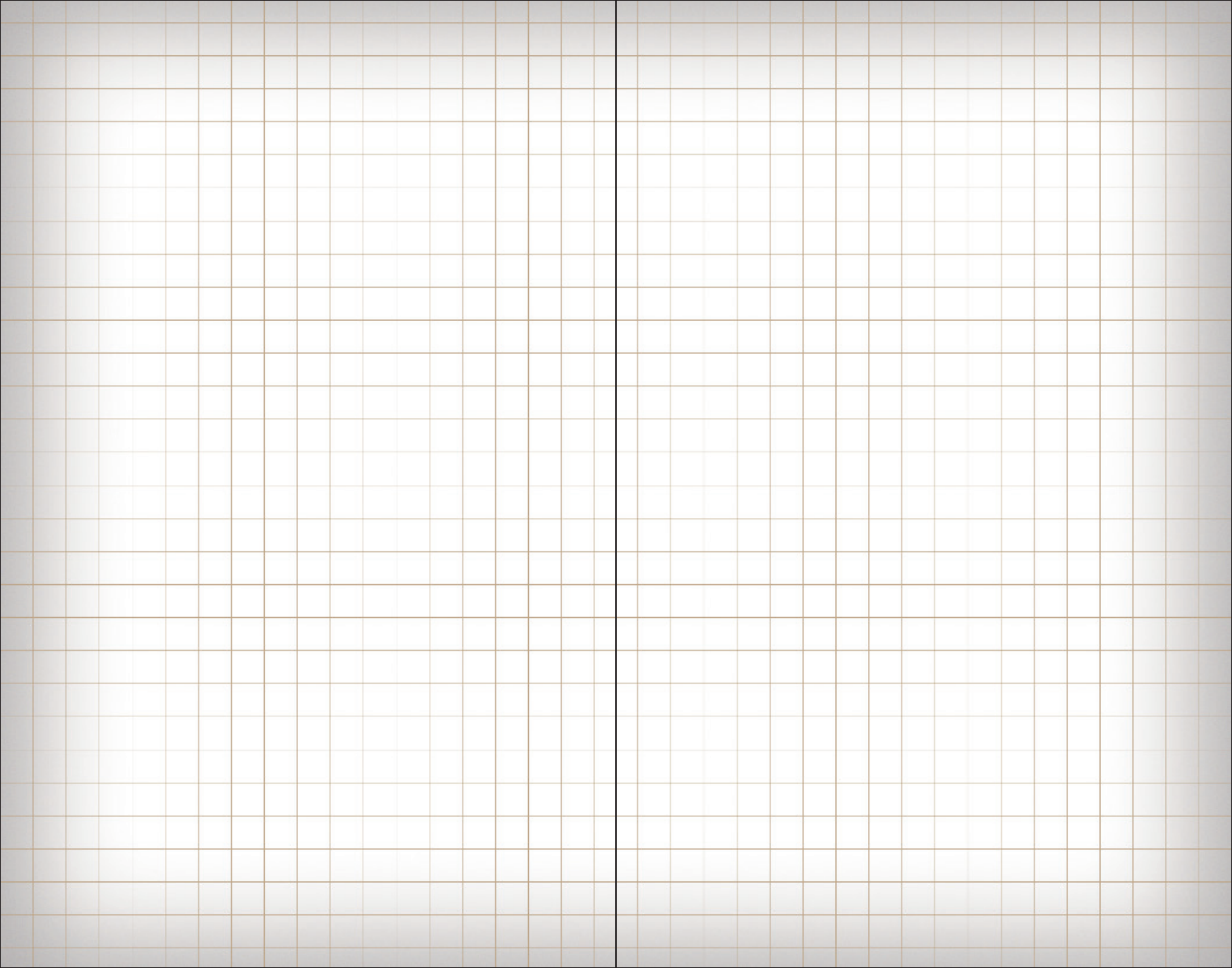

THE ROAD DOESN'T END
HERE.
THIS IS ONLY THE
BEGINNING.

GUTS-GLORY



RAM

RAMTRUCKS.COM